

COMPLETE STREETS IMPLEMENTATION WORKBOOK

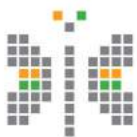

Smart City
MISSION TRANSFORM-NATION



Ministry of Housing and Urban Affairs
Government of India



The Smart City Mission encourages cities to create non-motorised transport infrastructure. Many cities have thus designed complete streets and are now in the process of implementation. Despite best intentions and good designs, improper planning of the construction process, along with poor execution and workmanship, result in construction errors and frequent excavations that affect the usability and attractiveness of these streets.

Smart Cities Mission - Ministry of Housing and Urban Affairs presents Volume 5 of the Complete Streets Toolkit, the 'Complete Streets Implementation Workbook', for Smart Cities across India. The document provides guidance for urban designers, municipal engineers, and contractors on construction detailing and management of complete streets, especially that of various over and underground utilities.

The document is divided into four sections:

- Pre-construction process
- Construction process
- Post-construction process
- Construction timeline

All the steps are presented in a chronological order such that the document can be used as a checklist itself. Every step is supported with onsite images from various Indian cities to make the document more contextually relevant and user-friendly. The users can also find sectional details for street elements and technical references (wherever applicable) in this document which might help them in the planning and execution process. With the advancement in technologies and innovations, there are various ways for executing the designs on site; this document aims to provide guidelines based on best practices in the field of construction.

This toolkit contains:

- i. Complete Streets Policy Framework
- ii. Complete Streets Policy Workbook
- iii. Complete Streets Planning Workbook
- iv. Complete Streets Design Workbook
- v. Complete Streets Implementation Workbook
- vi. Complete Streets Evaluation Metrics
- vii. Complete Streets Best Practices

April 2019



The Ministry of Housing and Urban Affairs is the apex authority of Government of India to formulate policies, coordinate the activities of various Central Ministries, State Governments and other nodal authorities and monitor programmes related to issues of housing and urban affairs in the country. The Smart Cities Mission was launched by the Ministry in 2015 to promote sustainable and inclusive cities that provide core infrastructure and give a decent quality of life to its citizens, a clean and sustainable environment and application of 'Smart' Solutions.



The Institute for Transportation and Development Policy works around the world to design and implement high quality transport and urban development systems and policy solutions that make cities more livable, equitable, and sustainable.

This project is part of the International Climate Initiative (IKI)

Supported by:

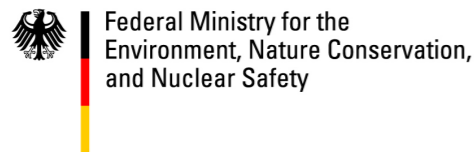

based on a decision of the German Bundestag

creating complete streets

Complete Street A street designed to cater to the needs of all users and activities, through equitable allocation of road space is referred to as a complete street.

Volume 01 of the Complete Streets Toolkit - Complete Streets Policy Framework - addresses the rationale for making improvements to streets.

Transforming successful pilots into larger city-wide networks of complete streets requires cities to embrace a progressive long-term vision. This can be achieved by adopting a Complete Streets Policy.

Volume 02 of the Complete Streets Toolkit - the Complete Streets Policy Workbook - for Smart Cities across India, provides a step-by-step approach for developing and adopting a Complete Streets Policy that is supported by a strong institutional set-up.

Volume 03 of the Complete Streets Toolkit - Complete Streets Planning Workbook - provides a step-by-step guidance to city officials, engineers, planners, and consultants on creating a city-wide walking and cycling networks.

The output created through this process includes a long-term master plan for a Complete Streets network with proposed phasing and estimated investment. This includes streets with continuous footpaths, segregated cycle tracks (where possible), safe intersections, uniform carriageways, and organised parking. It also includes greenways, pedestrian-only streets, non-motorised vehicle and public transport priority streets, shared-streets, and junction redesign projects.

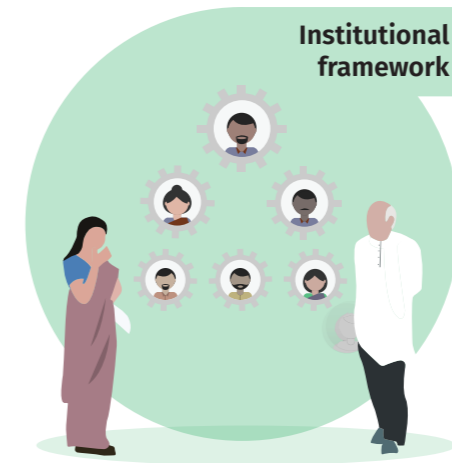

Creation of complete streets involves cooperation and collaboration between multiple stakeholders (such as ULBs, traffic police, planning agencies, consultants, experts, community groups, and others) at different stages, at both the city and the zonal level. Setting-up a dedicated committee and cell, as elaborated in volume 02, is an essential step to ensure the successful implementation of the Complete Streets projects.

It is important to obtain the reviews and approval from various stakeholders at each stage of the process of creation of complete streets to ensure that the end product caters to the expectations and needs of all.

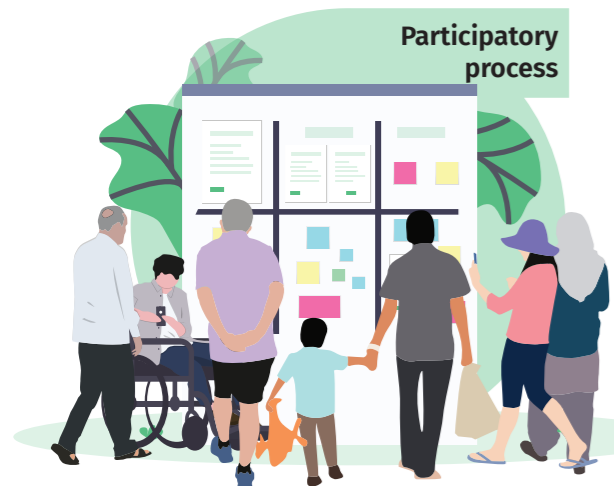
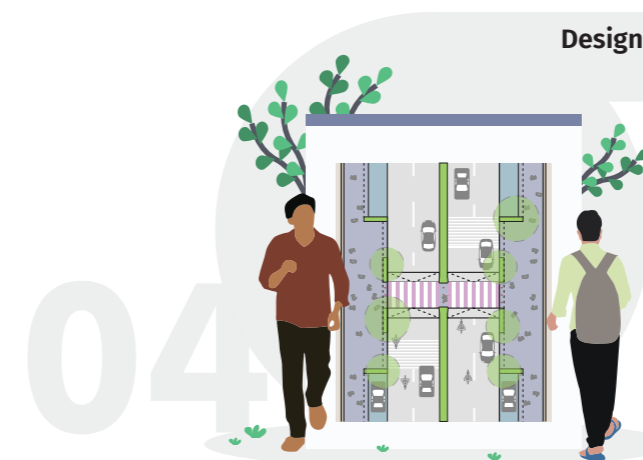
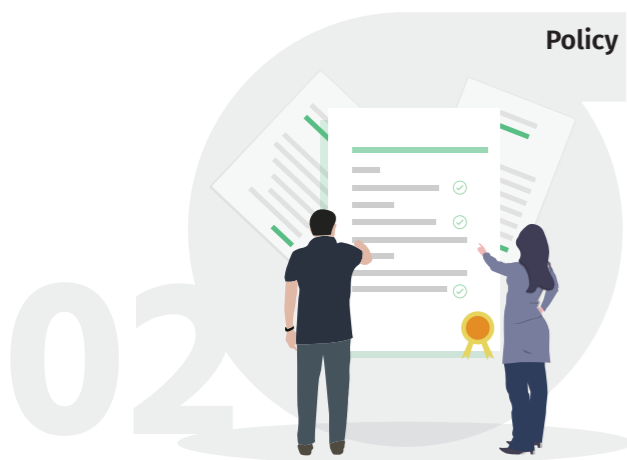

More often than not, the process of creating complete streets happens in isolation without involving the end users or the other agencies pivotal to the operation of the street. This leads to a disconnect between the local context and the design, which eventually renders the redesigned street unusable.

A participatory approach to street design involves the stakeholders - government representatives, public, NGOs, etc - in the design process to ensure that the final design caters to the needs of the intended users. The result of such a process is invariably more feasible and also innovative.

Many cities have initiated work on redesigning their streets. However, they are currently following different methods and standards due to the lack of a single guiding document for street design. There is, thus, an urgent need for a national-level document that serves as a guideline for the design of complete streets.

Volume 04 of the Complete Streets Toolkit - the Complete Streets Design Workbook - for Smart Cities across India, elaborates on the best practice standards and guidelines, as well as the process designing complete streets to city officials, engineers, urban designers, and consultants.

Apart from design execution, the mismanagement of the entire construction process can cause delays and inconvenience to residents. The diversion of traffic, dug-up roads with poor attention to on-site safety, obstruction at property entrances, and water logging add to the problems of residents.

Volume 05 of the Complete Streets Toolkit - the Complete Streets Implementation Workbook - for Smart Cities across India, aims to highlight the typical steps of project implementation that can ensure a good final product - a truly Complete Street.

contents

| | | |
|----------|----------------------------------|-----------|
| 1 | pre-construction process | 11 |
| | hiring a contractor | 12 |
| | roles and responsibilities | 13 |
| | implementation strategy | 14 |
| | pilot stretch selection | 15 |
| 2 | construction process | 17 |
| | pre-excavation | 18 |
| | construction of street edge | 24 |
| | construction of carriageway | 68 |
| 3 | post-construction process | 75 |
| | maintenance manual | 76 |
| | maintenance by contract | 77 |
| 4 | construction timeline | 79 |
| 5 | annexures | 83 |
| | request for proposals | 84 |
| | list of references | 96 |

List of acronyms

| | | | |
|--------|---|---------|--|
| BoQ | Bill of quantities | MRT | Mass Rapid Transit |
| BRR | Bus Route Roads | MS | Mild Steel |
| BRT | Bus Rapid Transit | MUZ | Multi-Utility Zone |
| CS | Complete Streets | MoRTH | The Ministry of Road Transport and Highways |
| CSMP | Complete Streets Master Plan | NMT | Non-Motorised Transport |
| DBM | Dense Bitumen Macadam | PCC | Plain Cement Concrete |
| DIP | Ductile Iron Pipes | PCU | Passenger Car Unit |
| DLC | Dry Lean Concrete | PMV | Personal Motor Vehicle |
| DWC | Double Wall Corrugated | PQC | Pavement Quality Concrete |
| FFL | Finished Floor Level | PVC | Polyvinyl Chloride |
| FRP | Fibre Reinforced Plastic | RCC | Reinforced Cement Concrete |
| GIS | Geographic Information System | RCC NP3 | Reinforced Cement Concrete - Non-Pressurised class 3 |
| HDPE | High Density Polyethylene | RfP | Request for Proposal |
| HRIDAY | Heritage City Development and Augmentation Yojana | RoW | Right-of-Way |
| IRC | The Indian Road Congress | ToR | Terms of Reference |
| IPT | Informal Public Transport | ULB | Urban Local Body |
| MEP | Mechanical, Electrical and Plumbing | WBM | Water Based Macadam |
| MLCP | Multi-Level Car Parking | WMM | Wet Mix Macadam |

definitions

| | |
|--|--|
| Accessibility | Facilities offered to people to reach social and economic opportunities, measured in terms of the time, money, comfort, and safety that is associated with reaching such opportunities. |
| Average trip length | The average distance covered by a transport mode for a trip. This is commonly measured in kilometres. |
| Bus Rapid Transit (BRT) | High quality bus-based mass transit system that delivers fast, comfortable, reliable, and cost-effective urban mobility through the provision of segregated right-of-way infrastructure, rapid and frequent operations, and excellence in marketing and customer service. |
| Bulb-out | Lateral extensions of the footpath into the carriageway to reduce the crossing distance for pedestrians. They reduce vehicle speeds, provide enhanced protection and visibility for pedestrians, and lower the time taken to cross the street. |
| Complete streets | Streets that are designed to cater to the needs of all users and activities, through equitable allocation of road space. Complete streets provide safe and inclusive environments that support users of all age groups, genders, and physical dispositions. They also guarantee efficient mobility by focusing on moving people, user safety, universal accessibility, vitality and liveability, sensitivity to local context, and environmental sustainability. |
| Eyes on the street | Informal surveillance of any street by the residents, shopkeepers, and other users of the street. |
| Greenway | A linear, landscaped pedestrian or bicycle route based on natural passages such as canals, rivers, or other scenic courses. It is typically for recreational use, with an emphasis on conserving and preserving vegetation. |
| Informal Public Transport (IPT) | This includes vehicles like share autos, vans, minibuses that operate on a shared or per seat basis on specific routes, in an unregulated or semi-regulated environment, and with no government support. The service may or may not have a predefined "fare structure". |
| Mass Rapid Transit (MRT) | A high quality public transport system characterised by high capacity, comfort, overall attractiveness, use of technology in passenger information system, and ensuring reliability using dedicated right of way for transit vehicles (i.e. rail tracks or bus lanes). |
| Mobility | Conditions under which an individual is capable of traveling in the urban environment. |
| Mode share | The share of total trips carried out by different modes of urban transport including, but not limited to walking, cycling, bus, rail, share auto-rickshaws, private auto, two wheelers, and cars. |
| Non-Motorised Transport (NMT) | All forms of human powered transportation including, but not limited to, walking and cycling. |
| On-street parking | The space occupied by parked vehicles along the edge of the street or carriageway which otherwise could have been used by motorised or non-motorised traffic. |
| Off-street parking | The term refers to the dedicated spaces provided for parked vehicles outside the right-of-way. It includes parking lots, multi-level car parking, and other off-street facilities. |
| Public Transport (PT) | Shared passenger vehicle which is publicly available for multiple users. |

A mechanism to facilitate efficient use of street space to ensure additional space dedicated for pedestrians, cyclists, public transport, and motorists. In addition, over time, collecting a fee for parking can manage its demand and ensure that personal motor vehicle users compensate the city for the use of valuable land on which they park their vehicles.

Measure of the width of the road taken from compound wall/edge on one side of the street to that on the other side.

This refers to the process of removing a pavement surface (asphalt, PCC, etc.) to improve the cross section and the surface profile, thereby preparing it for resurfacing.

A street where formal distinctions between spaces allocated for various users, is removed. The concept of shared streets is to ensure that each street user becomes progressively more aware and considerate of the others on the street. Specific design interventions can be made to force the vehicles to slow down and match the pace of those on foot.

The following modes are categorised as "sustainable modes" of urban transport because when compared with personal motor vehicles, they consume the least amount of road space and fuel per person-km and also cost much less to build the infrastructure: walking, cycling, and public transport (including a regular bus service as well as MRT systems).

Traffic calming measures ensure pedestrian and vehicle safety by reducing the speed of motor vehicles through vertical and/or horizontal displacements, real/perceived narrowing of carriageways, material/colour changes that signal conflict point, or complete closure of streets for vehicular traffic.

Parking management

Right of Way (RoW)

Scarification

Shared street

Sustainable transport modes

Traffic calming



implementation process

commencement of the process

It is a common misconception that the implementation process begins only after the completion of the design process.

While on-site construction starts once the design is ready and the drawings are completed, the implementation process commences immediately after the design consultant submits General Alignment Drawings (GADs) and Bill of Quantities (BoQ).

The city can then hire a contractor and initiate pre-construction formalities while the designer prepares Good for Construction (GfC) drawings.

The relationship between the design and implementation processes is as shown in the illustration below:

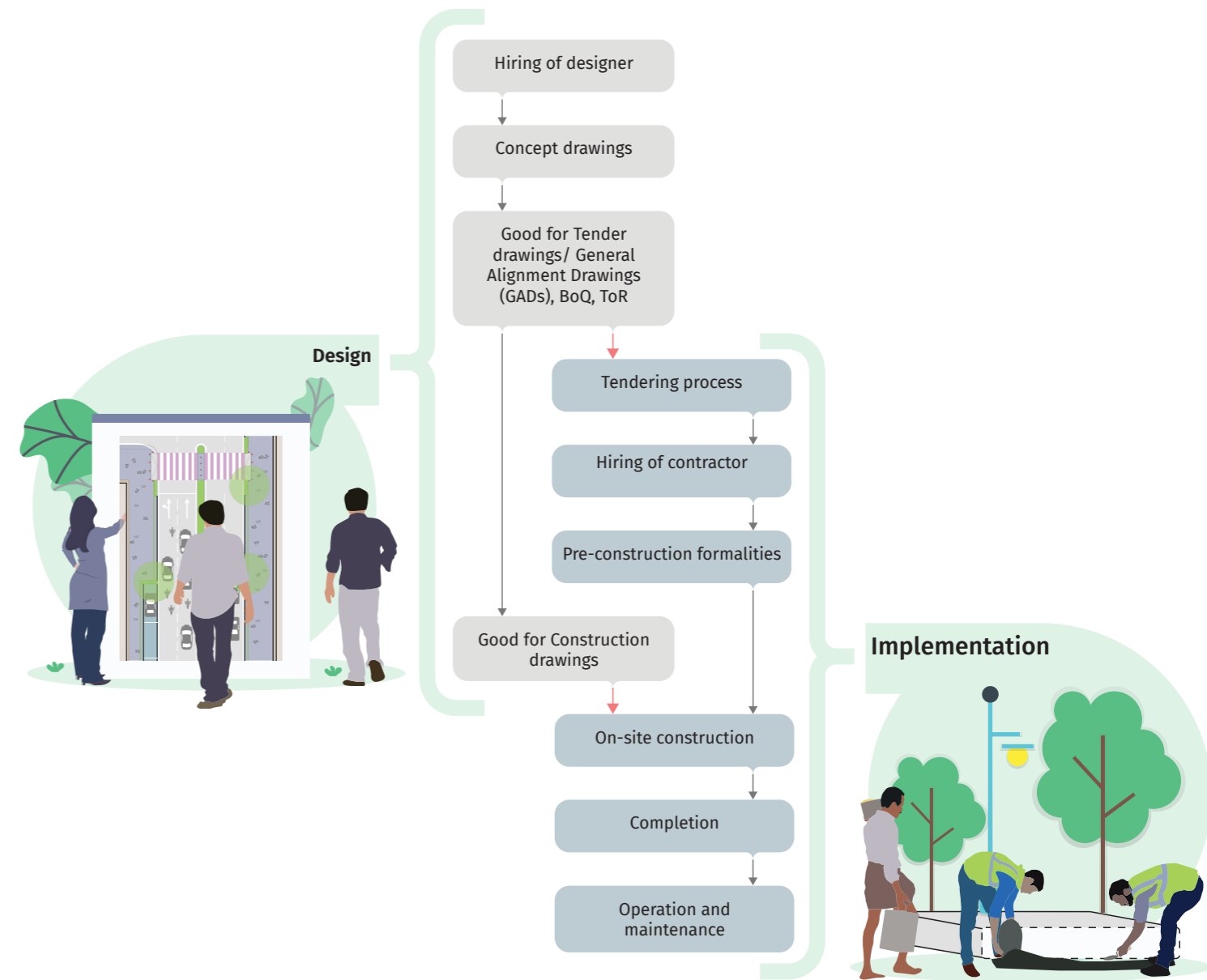

01

Pre-construction process

The implementation process begins prior to the commencement of on-site work, with the hiring of a qualified contractor. Responsibilities of all the stakeholders are listed out and an implementation strategy is provided by the contractor for smooth progress of the project. Following this, a pilot stretch is chosen from each package for construction and testing.



Hiring a contractor



Roles and responsibilities



Implementation strategy

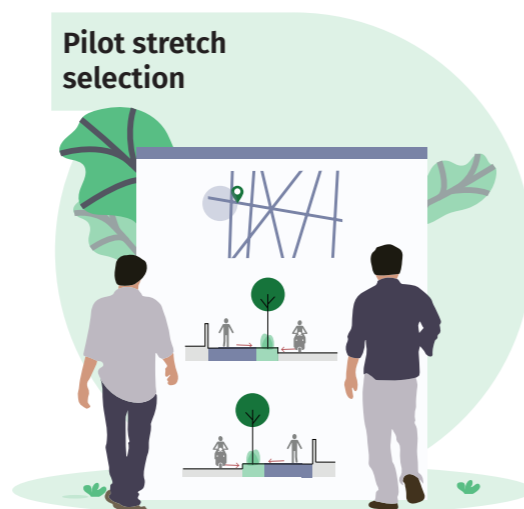

Pilot stretch selection



Pre-excitation

02

Construction process

Testing out the proposed designs and incorporating measures to ensure safety during construction, marks the beginning of the work on site. This is followed by the construction of the street edge including footpath, cycle track, street furniture, utilities, landscaping, and parking zones. Finally, the carriageway is re-laid, if necessary.



Construction of street edge



Construction of carriageway

03

Post-construction process

Regular maintenance of the completed work and management of landscape is crucial in ensuring safe and convenient user-experience. This section highlights the post-construction process of operation and maintenance of the project beyond the period of execution.



Post-construction process



PRE-CONSTRUCTION PROCESS

hiring a contractor | roles and responsibilities
implementation strategy | pilot stretch selection

1.1 hiring a contractor

The process of hiring a contractor for construction can start once the design consultant submits the Terms of Reference (TOR) for the same.

work experience

Stringent eligibility and bid criteria can ensure the selection of a good contracting agency. The contractor's annual turnover and experience of working in the field with the government on projects of similar scale, should decide the eligibility of the bidder. Eligible contractors must have a good track record and experience in all of the following works:

- Construction of urban roads/streets and footpaths.
- Construction of urban drains (above-ground and underground), setting up of distribution network for utilities, shifting overhead power cables underground.
- Street lighting especially at medians and kerbside.
- Junction improvements.

The contractor should also be aware of, and skilled at using the latest innovative construction techniques. During the pre-bid meetings, the contractor should be acquainted with the workmanship standards and citizen consultation skills required for such projects.

team composition

The execution team should have experienced professionals like Project Manager and Engineer, Site Engineer and Supervisor, a Mechanical, Electrical and Plumbing (MEP) expert, Architect, and a Quality Assurance Engineer as part of the team. It is also recommended to have a Landscape expert in the team to guide the excavation and demolition process without damaging existing trees.

The completion of the project depends on the number of teams a contractor can deploy simultaneously for different works. The contractor can create an efficient team through sub-consulting as well.



Fig.
The team of consultants
at a review meeting in
Coimbatore Corporation

roles and responsibilities 1.2

Strong political will, good administrative leadership, and a collaborative approach are all equally important to make the street construction project successful, with each stakeholder having specific roles to play.

| Stakeholder | Roles and responsibilities |
|--|---|
| Contractor | <ul style="list-style-type: none"> • Ensure timely execution of the project while meeting specifications, workmanship standards, safety and traffic management on the site • Ensure regular clearance of debris • Facilitate the needs of local residents; provide alternate temporary facilities for vehicular and pedestrian movement • Have an on-site office • Coordinate with adjoining property owners and resident bodies, when required, to cause minimum inconvenience |
| Municipal Corporation authorities and engineers | <ul style="list-style-type: none"> • Facilitate stakeholder meetings • Grant work permits and provide no-objection certificates • Make payments to the contractor on-time, as per tender • Facilitate coordination with internal and external agencies for utility works |
| Apex committee (Includes top level authorities, department heads, and experts) | <ul style="list-style-type: none"> • Act as the decision-making body • Address on-going coordination and technical issues • Approve budgets |
| Utility agencies | <ul style="list-style-type: none"> • Assist in mapping existing utilities • Assist in mapping proposed projects if any, such as shifting of overhead cables to underground, laying new cables, etc. • Provide information on future requirements • Approve proposed details and relevant drawings • Provide no-objection certificates |
| Designer | <ul style="list-style-type: none"> • Coordinate with contractor • Facilitate the contractor's training by explaining the design, drawings, and materials used • Ensure timely site visits • Revise the plans based on site conditions, if necessary and produce 'As Constructed' drawings • Involve adjoining property owners and resident bodies whenever required, to cause minimum inconvenience |
| Street Design Cell (if it exists) or Project Management Consultant | <ul style="list-style-type: none"> • Identify contractors for implementation and oversee the work periodically • Coordinate with contractors and consultants to address on-site issues during construction • Mediate any conflict among stakeholders (both public and governmental) during construction • Ensure quality control • Ensure maintenance of the physical infrastructure as per standards developed by the cell or as specified in these guidelines, with periodic monitoring • Involve adjoining property owners and resident bodies when required, to cause minimum inconvenience |
| Traffic police | <ul style="list-style-type: none"> • Manage traffic (one-ways and diversions) and parking during construction • Provide permissions for construction work |

Table 01:
Roles and responsibilities of
various stakeholders during
the implementation process

1.3 implementation strategy

planning

Before starting on-site work, the contractor needs to prepare strategic implementation plans. These plans help obtain approvals from various agencies and authorities in time, and assist in coordinating with traffic police, on-site engineers, and citizens for hassle-free execution of work.

| Plans | Constituents |
|--------------------------------------|--|
| Detailed Programme of Work | <ul style="list-style-type: none"> • Details of workforce deployment, procurement of materials, equipments, and time required to execute the work as per the implementation schedule • To be closely linked to on-ground surveys, especially mapping of underground utilities and their connections to individual properties along the street |
| Procurement Plan | <ul style="list-style-type: none"> • Procurement schedule for all materials including but not limited to utility services, landscape elements, site furnishings, lighting, bus stops, etc. • Information of suppliers • Availability of materials |
| Product samples | <ul style="list-style-type: none"> • Type and number of samples of all street elements and furniture including landscape species, as specified in the design, to be displayed at the site office |
| Site Management Plan | <ul style="list-style-type: none"> • A site arrangement layout for the location of temporary structures, storage, water and electricity supply for the duration of the implementation work on site • A waste management plan for the site |
| Phasing plan with Traffic management | <ul style="list-style-type: none"> • Project specific Traffic Management Plan for the duration of the construction, as per IRC:SP:55*, before the start of any activity on site • Suitable strategies in case of lane construction, lane closure, shared right-of way, temporary by-pass, detours, crossovers, etc., during implementation • Diversion routes for buses and other vehicles based on the maps of bus routes, one-ways and traffic movement prepared by the designers <p>The Traffic Management Plan is submitted to the Independent Engineer for review. While creating the plan, it should be ensured that the impact of temporary interruptions to vehicles and pedestrians, caused by on-site implementation, are properly addressed by the authorities</p> |
| Communication plan | <ul style="list-style-type: none"> • A plan with construction timelines and broad work schedules for the local residents |
| Quality control | <ul style="list-style-type: none"> • Arrangements for additional/confirmatory testing of any material including imported materials/products, as per an approved Quality Assurance Plan (QAP) |

Table 02:
Implementation strategies
and their constituents, to be
provided by the contractor
before the commencement
of any work on site

* IRC:SP:55- Guidelines On Traffic Management In Work Zones

pilot stretch selection 1.4

Successfully constructing an initial part of the street (also known as the pilot stretch) helps showcase the comfort and usability of high-quality walking and cycling infrastructure. This in turn garners immense public support for the project and paves the way for its smooth execution.

what successful pilots achieve

Streets are interspersed all across a city and hence, should be apportioned into packages for the purpose of redesign. Following this, each package should have a pilot stretch of its own to display the transformation and design execution.

selection of streets

The selection of these pilot streets should be based on ease of execution, completion of formalities, minimal on-site obstructions, and maximum impact. To ensure quick and efficient construction, it is pertinent that traffic is managed properly. Pilot stretches offer good opportunities for learning which then helps in efficiently scaling up the project.

The streets to be redesigned should be divided into multiple 'chainages', each with its own specific reference points and centreline alignments. The chainage numbers help in easier identification of stretches for monitoring and supervision purposes.



Fig:
Workshop in Erode for the
selection of streets



CONSTRUCTION PROCESS

pre-excavation | construction of street edge | construction of carriageway

2.1 pre-excavation

a temporary markings

The contractor shall provide all labour, survey instruments, and materials such as paints and brushes, strings, pegs, nails, bamboo, stones, lime, mortar, concrete, etc., required for marking on street along with appropriate safety measures.

street centreline The centreline, as identified in the design stage, should be accurately marked on the street as per the drawings.

- The consultant should take the help of the city engineers for marking the lines.
- Paint/chalk can be used to mark the centreline, along with pegs in case the former washes off.



Fig. (above)
Street centreline marking on a street in Chennai

Fig. (below)
Street centreline marking on DB Road, Coimbatore



The footpath kerb, parking bays and property entrances should be marked using paint/ chalk powder as per the design. This helps in conducting trials and also during excavation.

kerb line

- Marking on the road should preferably be done at night when vehicular movement is less and manageable.
- Support & cooperation from the Traffic Police is necessary for traffic management, especially at night.
- At intersections, kerb line marking should start 10 m from the corner to allow for adjustment of the turning radii as required.

The longitudinal section of the street/ footpath also needs to be marked along the edge of the street to make sure that the design does not affect property access and stormwater drain alignment. The locations of utility chambers especially sewer, storm water and telecom, need to be planned and marked to avoid them at critical locations on the street.

longitudinal section



Fig. (above)
Kerb line marking in a street in Chennai

Fig. (below)
Marking the corner of DB Road intersection in Coimbatore, at the end to allow for adjusting the turning radii as per drawing and site conditions

b trial run

Testing the proposal on-ground allows the designers, contractors, and engineers to understand the changes required in the design. Trials are generally carried out at intersections rather than the entire street as the former require a greater level of thought and detailing. Before implementing the trial run, the contractor should prepare a plan of action which needs to be approved by the Municipal Corporation and Traffic Police whose support is vital for traffic management during the trial.

The trial run should be carried out for at least 1-2 weeks at a stretch. Appealing design patterns and other tactical interventions encourage usage during the trial run and thus help validate the design. Cones, ribbons, and barricades used to mark out the design, help in streamlining vehicular movement and provide for quick changes during the trial.



Fig. (above)
Appealing design patterns seen during a trial run at DB Road in Coimbatore



Fig. (below)
Barricades used to mark out the design at an intersection trial in Cathedral Road, Chennai

Pop-Up MANGo Tactical Urbanism | YouTube
<https://youtu.be/2EQo7iWONEU>

Tactical Urbanism - Adyar Junction | YouTube
https://youtu.be/X63JJ6G3_IA

c utility mapping

Mapping of all utility lines running underground is necessary for precise excavation so as to prevent damage to these lines.

Ideally, utility mapping should be done by the Corporation and the respective line agencies as a separate project, prior to the commencement of design of the streets. In the absence of such a map, the design consultant should collect this information from the respective line agencies.

Alternatively, the contractor can dig trial pits at regular intervals of 50-70 m or use non-invasive techniques like the LiDAR survey to locate the underground utilities, in the presence of the respective line agency representatives.



above-ground utilities

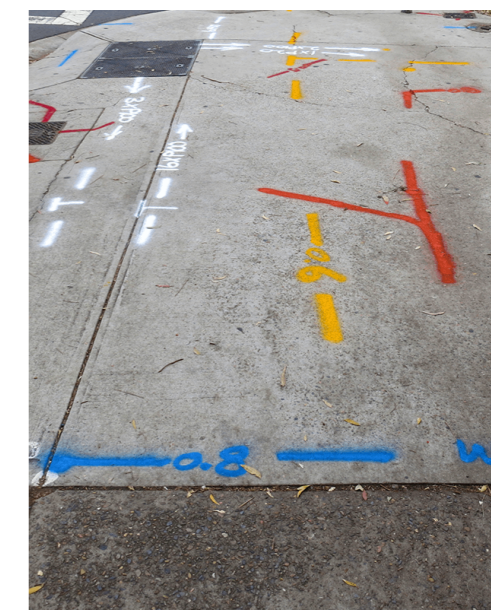

underground utilities

Fig. (top left)
Utility poles with overhead wires, surface-mounted feeder pillars, utility mains, transformers etc.

Fig. (top right)
The utilities being marked on site for upgradation, consolidation, realignment or installation

Fig. (bottom left)
Invasive technique: Trial pit

Fig. (bottom right)
Non-invasive technique: LiDAR survey (Source: Locating Services Underground Utilities Pty Ltd)

d other formalities

Other formalities to be taken care of by the contractor and engineers prior to the execution of work on site, include:

- Obtaining necessary permissions from concerned government authorities.
- Barricading the site and providing reflectors, retro-reflective sign boards, lighting, etc.
- Abiding by safety regulations for the safety of workers and other users on-site.
- Liaising closely with the owners of private properties and shops for any reconstruction, reinstatement and relocation work, to minimise any inconvenience.



sample stretch e

It is advisable to construct a sample stretch of minimum length, following the proposed design. While there is only one pilot street per package, there may be multiple sample stretches in a package, depending on the design of the streets.

Sample stretches may be temporary or permanent. They help in showcasing the design of the street with the choice of materials, street furniture and the workmanship to the stakeholders. In addition, visualisations of the proposed design can be displayed to help the stakeholders envisage the transformation of the entire street.



Fig. (above)
ITI Road, Pune

Fig. (below)
DP Road, Aundh, Pune

Fig. (above)
A 15 m long sample stretch
at JM Road, Pune

Fig. (below)
Children using the 50 m
sample stretch constructed
at T.Nagar, Chennai

2.2 construction of street edge

demolition 2.2.1

contingency In spite of fairly accurate designs, there is always need for on-site improvisation due to unexpected situations. Issues pertaining to permissions, procurement, weather, festivals, obstructions, political and/or public pressure or other on-site conditions could affect the execution. Quick decisions need to be taken by the team to devise techniques to overcome these issues and maintain the flow of work.

street edge Street edge includes all kerbside components like footpaths, cycle tracks, vending spaces, parking bays, landscaping, etc. The length of the stretch to be undertaken for construction at a time depends on the number of teams to be deployed by the contractor for different stages of work.

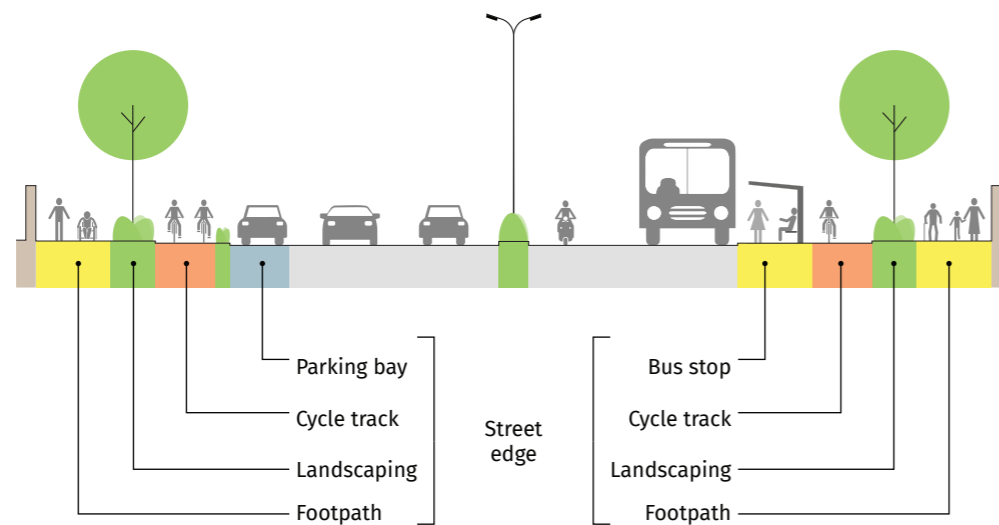

The implementing agency is responsible to ensure the safety of workers on site. Additional safety measures like provision of alternative arrangements, barricading, signages, etc. need to be provided throughout the work zone for the safety of pedestrians and vehicular traffic.



Fig. Street edge under construction on ITI Road, Pune

Some projects might require only the footpath to be demolished, while others might involve demolition and excavation of the entire ROW. The decision to demolish or retain any subsurface component like drains and trenches, and superstructure including utility boxes, electric poles, lamp posts, etc. should be made during the design stage in consultation with the respective line agencies. Existing components, if reusable, can be used in the proposed section strictly under the supervision of the engineer in charge.



Fig. (above) The site is marked to be demolished/scarified/ excavated at ITI Road in Pune

Fig. (below) Footpath demolition and carriageway tilling at FC Road in Pune

demolition of footpath

Debris resulting from the demolition of the existing footpath causes health and safety hazard, in addition to being an inconvenience to the public. To prevent this, debris should be disposed off at regular intervals as per IRC and other relevant guidelines.



The construction of footpath should be completed on one side of the street before commencing work on the other side. This would result in minimum disruptions to pedestrian and vehicular traffic.



Fig. (above)
Debris being cleared from
DB Road in Coimbatore

Fig. (below)
Footpath on one side of the
street in Coimbatore being
demolished

Carriageway tilling and scarification requires heavy vehicles like dumpster trucks, JCBs and rollers. There should be constant supervision to ensure safety while parking and using these heavy vehicles.



Alternative temporary arrangements have to be made by the contractor for affected entrances, boundary walls, and gates of adjoining properties. After completion of work, the contractor should restore the affected portions.



carriageway tilling

alternative arrangements

Fig. (above)
Debris being cleared from FC
Road in Pune

Fig. (below)
Alternative access arrangement
made by the contractor in
Coimbatore

2.2.2 subsurface work

excavation 2.2.2.A

Subsurface work includes the following steps:

- Excavation of the earth
- Provision of base for utilities
- Management of underground utilities
- Backfilling
- Provision of sub-base

In the entire process of implementation, subsurface work requires maximum coordination between the contractor, design consultants, utility agencies, and the traffic police.

Traffic Police, contractor, engineers, designers, MEP expert and a landscape specialist are preferred to manage excavation around existing trees. Members from concerned line agencies should be present on-site during excavation. The utility lines, if damaged at this stage, should be repaired by the respective agencies to avoid disruption in services.

authorities involved

Excavation should be planned to suit the depth at which the utility lines are to be laid. Precautions need to be taken to reduce the number of punctures/ breakages to existing utilities and to protect the soil in case of deep excavation (for stormwater utilities etc). At least 2 m around tree trunk should be left unexcavated to prevent damage to the roots.



Fig.
Subsurface work in progress
in FC Road, Pune



Fig. (above)
Excavation work carried
out in Coimbatore ahead of
the rainy season to prevent
stagnation of water

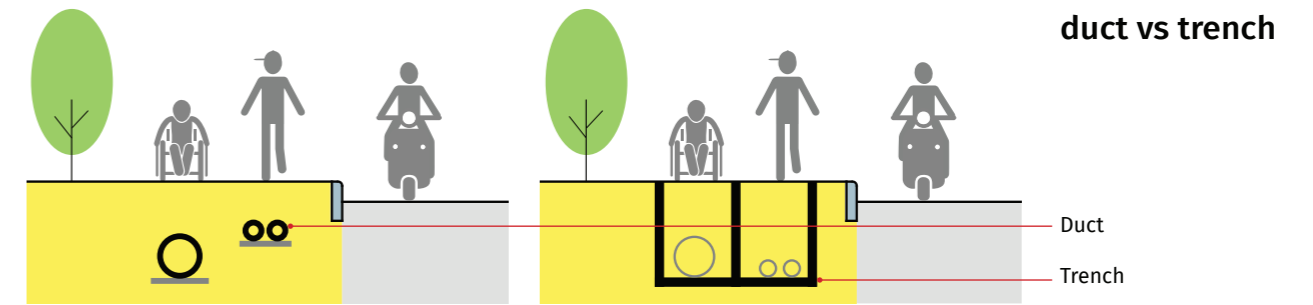

Fig. (below)
Excavation work carried
out in Coimbatore without
causing damage to the
foundations of adjoining
boundary walls

2.2.2.B utilities management

Utility lines are carried either through ducts or trenches and are accessed through manholes at intervals of 25 to 30m. Provisions are made for utility lines to be laid across the street at regular intervals and for connections to individual properties. The consultant should create a set of plans and sections showing existing, relocated, and proposed utility lines along with manholes, for future reference.

duct Ducts, also referred to as 'conduits', 'tubes' or 'pipes', are long-lasting casing pipes (RCC/HDPE/GI/PVC) which carry utility lines and are buried directly in the ground on a PCC bed/compacted soil layer, eliminating the need for a concrete passage.



Ducts are recommended for all underground utilities, provided that manholes are located at regular intervals. "Installation of service lines through casing pipes facilitates easy withdrawal of the carrier line in case of maintenance or replacement without need for cutting the road. Interference to traffic and disturbance to pavement structure are avoided." - IRC: 98-1997 (Guidelines On Accommodation Of Utility Services On Roads In Urban Areas)

trench A trench/utility tunnel, also referred to as 'gully', 'chamber', 'gutter', is a concrete passage built underground to carry utility lines, covered with an in-situ concrete slab or a precast concrete cover.



Private Property stormwater (existing) telecommunication (govt. & private) water & rider sewer electrical

Fig. (top left to right) RCC Hume pipes; HDPE pipes (Source: Wikimedia commons); Double wall corrugated HDPE Pipe

Fig. (bottom) Network of proposed and existing trenches under construction for a sample stretch in Coimbatore











| Aspects | Duct vs Trench | |
|----------------|--|---|
| Location |  vs  | Trenches are better suited on stretches with no obstacles and hence are not ideal in urban areas. |
| Cost |  vs  | The laying of ducts costs only 30-35% as that of the construction of trenches.* |
| Time |  vs  | Ducts require less time for execution than trenches. |
| Flexibility |  vs  | Ducts provide greater flexibility and can be maneuvered around trees & obstructions. |
| Sustainability |  vs  | Ducts are more environmentally sustainable compared to trenches, as trenches use cement concrete for construction, prevent rain water percolation, & obstruct growth of tree roots. |

Fig. (top left) Ducts in DP Road, Pune

Fig. (top right) Trench under construction in Chennai

Table 03: Advantages of ducts over trenches

* TenderSURE Specifications for Urban Roads Execution

manholes

Manholes are underground chambers through which utility lines can be accessed for cleaning, repair, replacement, and drawing future connections. The exact details for provision of manholes for different utilities should be obtained from the respective utility departments.

Manhole covers should be of non-corrosive, strong material with low resale value to avoid theft. Longer lasting precast concrete manholes may be preferred. Manholes should be avoided on cycle tracks. It is recommended that manholes be provided on the bulb-outs of the footpath.



Fig. (top left)
Multiple utility lines in one manhole due to lack of space in DP Road, Pune

Fig. (top right)
Manhole covers aligned with the footpath finish level

Fig. (bottom left)
Conical manhole for stormwater in DP Road, Pune

Fig. (bottom right)
Manhole under construction with precise measurement in FC Road, Pune

Fig. (top left)
Manholes at bulbouts and utilities at tree pits in JM Road, Pune

Fig. (top right)
Manholes should not be on cycle tracks unlike as seen in PT Rajan Road, Chennai

Fig. (bottom left)
Manholes provided at regular intervals in consultation with the respective agencies, in NSC Bose Road, Chennai

Fig. (bottom right)
Different types of manholes for different utilities (circular, rectangular, FRC, RCC) in DP Road, Pune

existing utilities

In many Indian cities, the utilities have been laid years ago in a haphazard manner, due to organic growth of the cities. As a result, detailed documentation of underground utilities with the exact location and alignment, might not be available with the respective line agencies.

The Complete Streets project is an opportunity for rearranging and documenting all the utilities (both underground and above-ground), providing new utilities to meet the current demand, and make additional provisions and infrastructure for future needs.

It is the responsibility of the contractor to execute all construction work, including excavation and laying new elements or utilities, in conjunction with the existing utilities and services both above and below the ground level.

Contractor has to inform the concerned line department immediately if any underground services are found hindering the work, and further any re-alignment or damage of the services has to be repaired as per instruction from line department. The contractor has to anticipate the material quantity and time required to reinstall the utilities and restore the services.

Existing utilities present underground are :

DRAINAGE: open or closed trenches, catchment pits, silt traps, RCC hume pipes for stormwater and sewage

ELECTRICAL: low and high tension cables, connections to streetlights, CCTVs

TELECOM: copper and optic fibre cables for government and private telecom operators

Other lines for utilities like gas, defunct and abandoned lines, damaged lines, etc.



Fig. Complex network of existing underground utilities at different levels in DP Road, Pune

Where trees obstruct the continuous passage of new utility lines, the lines should be carried around the trees via ducts as shown in the figure below*. Lines that carry viscous content like sewer lines/SWD have larger diameters and hence cannot be easily manoeuvred around trees. Additional manholes would be required in these cases, as shown.

Technical advice from a horticulturist is recommended. Transplantation is the last resort and should be decided based on an expert counsel depending on the tree species. Also, the placement of utilities should be coordinated with the location of trees so that the latter are not disturbed if utilities are dug up for maintenance or replacement.

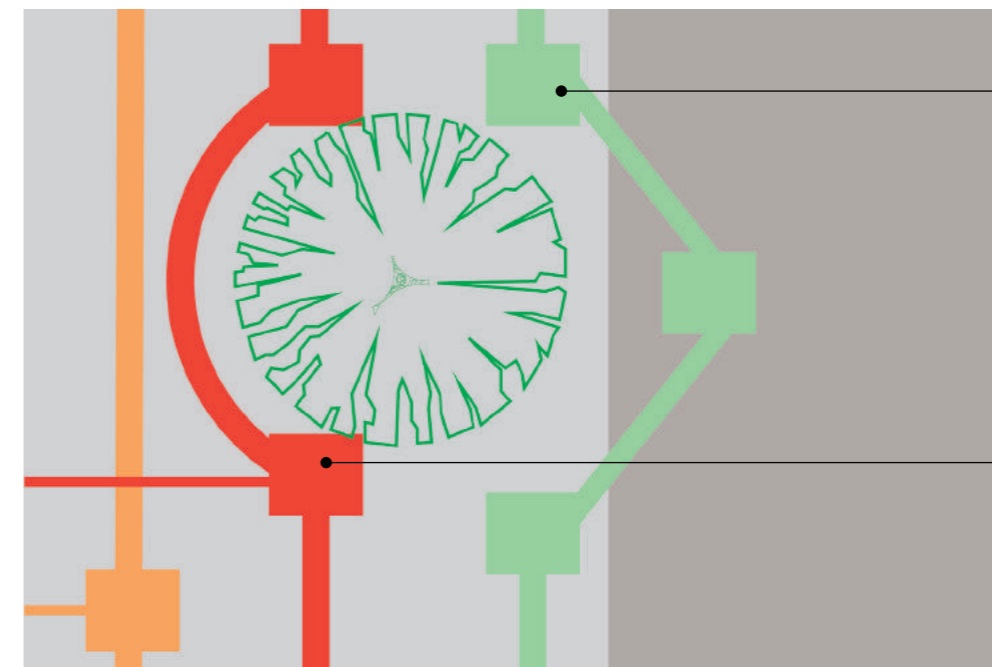

utilities around trees

Viscous content
Sewer, water and stormwater lines are diverted through a series of manholes

Dry utilities
Other utilities can be maneuvered around the tree through a flexible duct

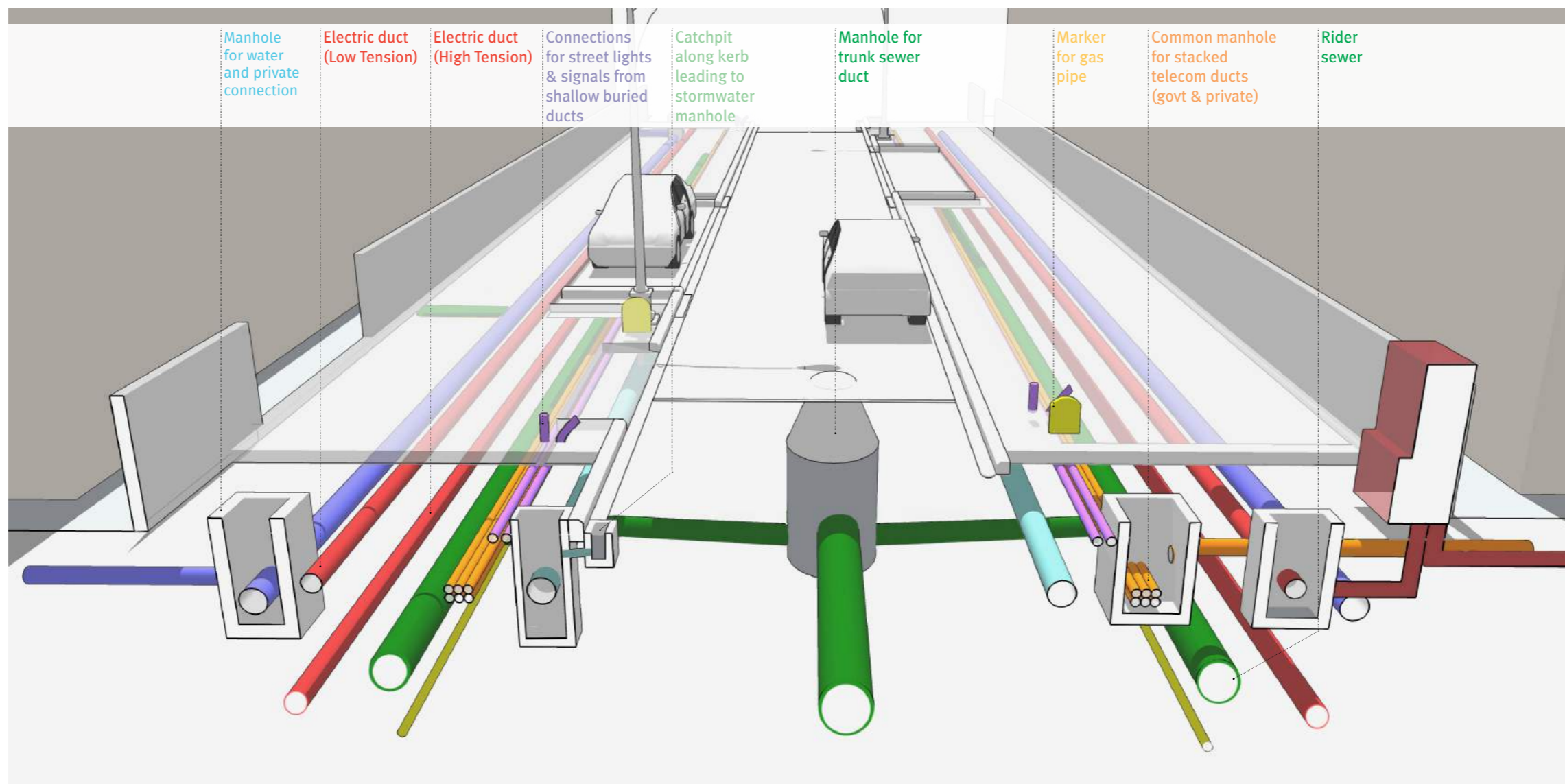

Fig. (left) Damage caused by excavating beyond 2 m around trees in Coimbatore

Fig. (right) Utility lines maneuvered around the tree through ducts in Bangalore

* TenderSURE Specifications for Urban Roads Execution

2.2.2.C proposed underground utilities



| Category | Water | Electricity | | Street Lighting & other fixtures | | Stormwater |
|-----------------|--------------|-------------|--------------|----------------------------------|-----------|-------------|
| | Utility Type | Low-tension | High-tension | Side lines | At median | Main |
| Duct Material | MS/DIP | HDPE DWC | RCC-NP3 | HDPE | HDPE | RCC-NP3 |
| Duct size (dia) | 150-300 mm | 150-300 mm | 300-450 mm | 100-200 mm | 300 mm | 500-1200 mm |
| Depth | 1-1.5 m | 0.6-1 m | 1.5-2 m | 0-0.6 m | 0.6-1 m | 0.6-1 m |

| Category | Sewage | | Telecommunications | | Private connections | Additional ducts |
|-----------------|---------------|----------------------------|--------------------|------------------|---------------------|------------------|
| | Rider sewer | Trunk sewer (under median) | Copper cables | Optic Fibres OFC | For each utility | Future additions |
| Duct Material | RCC Hume Pipe | RCC Hume Pipe | HDPE | HDPE | PVC/HDPE | HDPE |
| Duct size (dia) | 300-450 mm | 500-1000 mm | 100-300 mm | 100-300 mm | 100 mm | 150 mm |
| Depth | 0.6-1 m | 2-6 m | 0.6-1 m | 0.6-1 m | 0.6-1 m | 0.6-1 m |

Fig. (above) Underground utilities* across the road

* IRC: 98-1997- Guidelines On Accommodation Of Utility Services On Roads In Urban Areas

typical cross-section across utilities

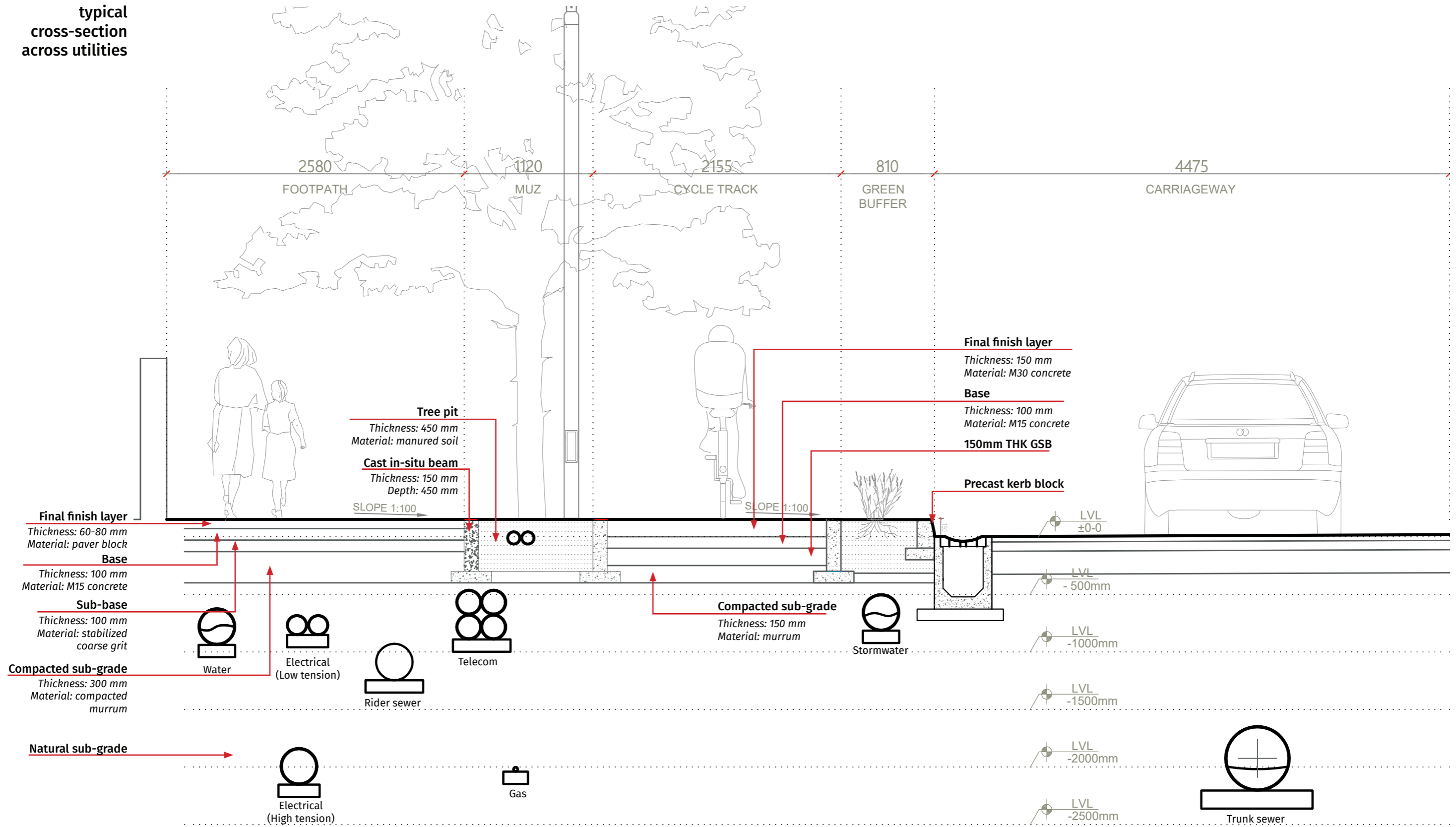
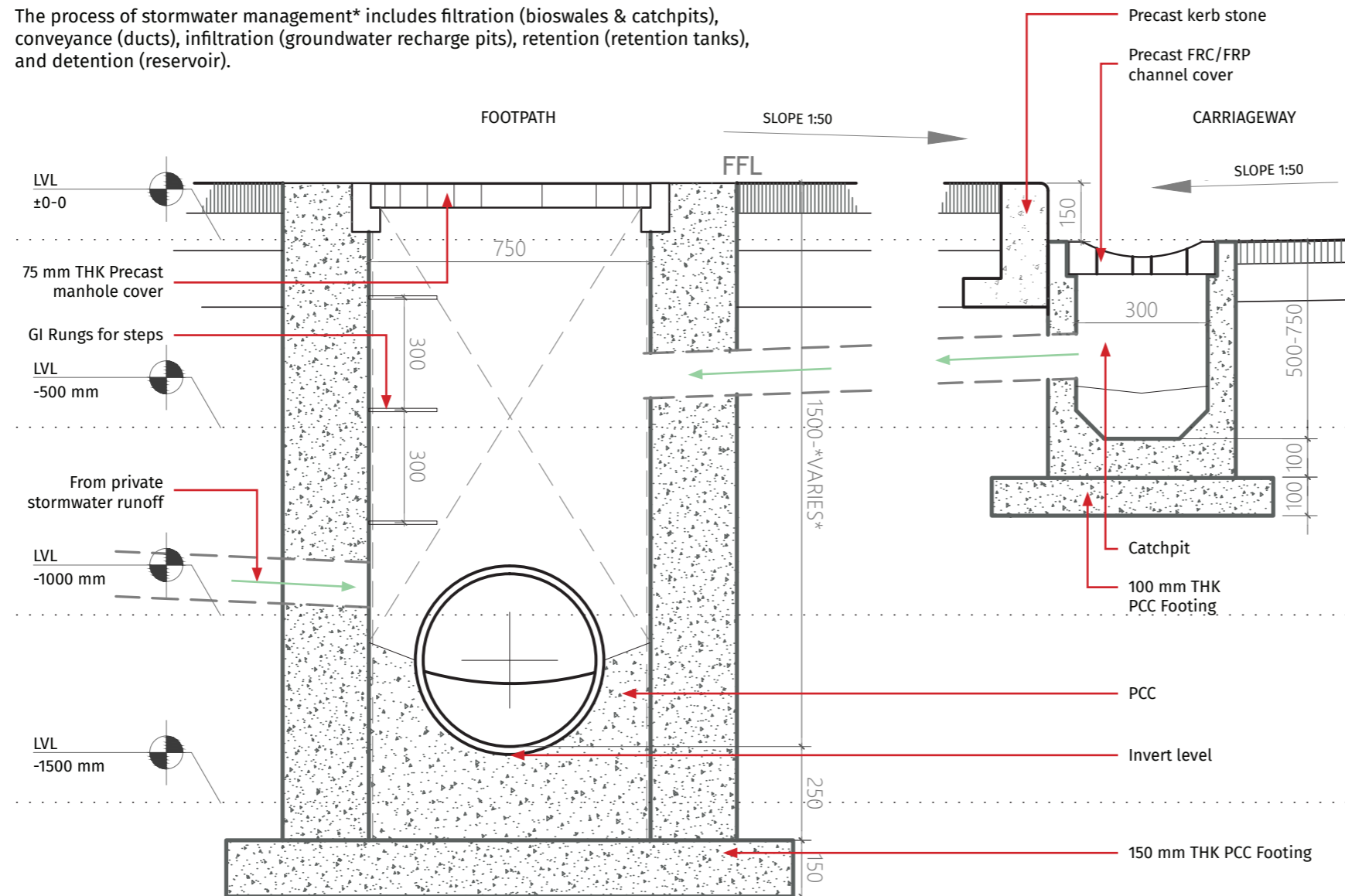

Fig. Typical cross-section across underground utilities

A stormwater

The process of stormwater management* includes filtration (bioswales & catchpits), conveyance (ducts), infiltration (groundwater recharge pits), retention (retention tanks), and detention (reservoir).

detail



key section

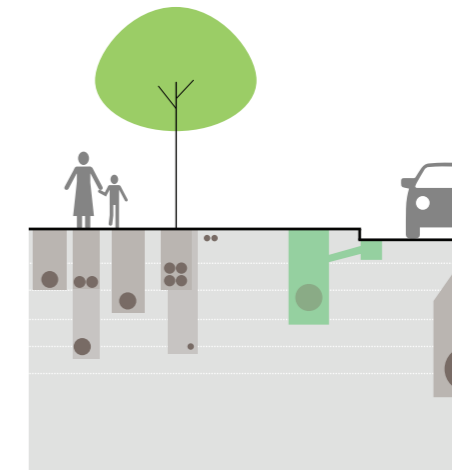

preferred location

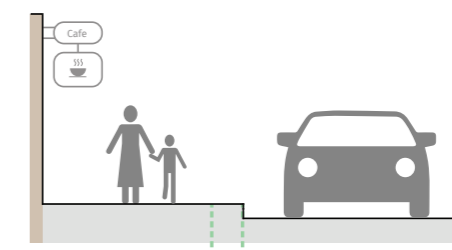

location

Along carriageway edge with silt catch pits at regular intervals

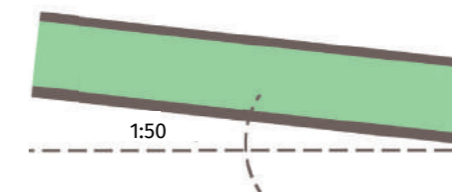

slope

Ducts should be laid inclined at 1:50 slope to encourage gravitational flow of water.

special cases

Where catchpits are avoided and ducts lead directly to manholes, they should be cleaned especially before and after monsoon.



connections

Connections from other utilities to properties can be easily made over ducts, making them advantageous over conventional trenches.



illegal connections

Illegal sewer connections into stormwater drain are prevented when ducts are used instead of trenches.

Fig. (above)
Typical section across manhole for stormwater drain, showing the manhole and catchpit connection

Fig. (below)
Laying of 1 m dia RCC ducts for stormwater drain in DP Road, Pune



* For detailed guidelines, please refer to IRC-SP-50 2013 - Guidelines on urban drainage

In most cities in India, there is an existing network of stormwater trenches. In some cases, it is sustainable to reuse the existing trench after desilting, to carry other utility lines as well. Proposed stormwater ducts and existing trenches can be connected through manholes while maintaining the desired slope.

stormwater drainage network

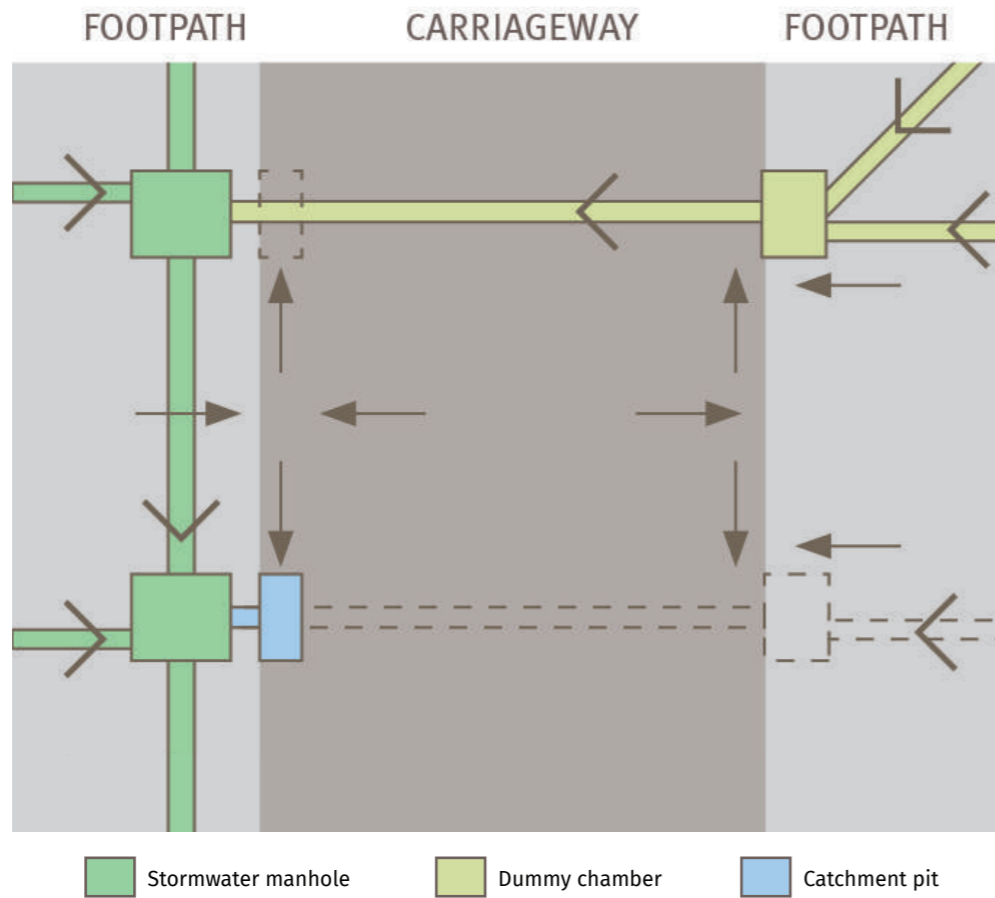

stormwater manhole

Stormwater manholes collect water from the adjacent properties through ducts and from catchpits. They can have kerb-inlets on the surface to collect runoff water, removing the need for separate catchpits.

dummy chamber

Dummy chambers act as intermediate manholes in stretches where lack of road space does not allow for a continuous stormwater duct. These chambers collect surface runoff and water from adjacent properties, which is then carried to the stormwater duct on the other side.

catchment pit

Catchment pits collect surface runoff from the carriageway, sidewalk, and private properties. The longitudinal and transverse gradient of the surface should be maintained as mentioned in IRC-SP-50 2013 (Guidelines on Urban Drainage) which recommends cross slopes of 2-2.5% for travel lanes.

Stormwater from the road flows along the saucer drain (along the kerb) into the catchment pit through inlets. Catchment or catch pits are designed such that silt is collected in the chamber through sand/gravel filters before the water flows into the main stormwater drain.

The depth of the catchpit can vary from 450-600 mm, with a width of approximately 300mm. Catchpits should be located at the lowest point of the street cross-section and at regular intervals decided by their size, average rainfall, and the catchment area.

Catchpits are protected with grating to prevent solid waste from entering the chambers. Openings to catchpits should be at grade with the surrounding carriageway surface.

openings



Horizontal opening along the saucer drain

Vertical openings along the kerb

The openings can be into catchpits or directly into the storm water drain, depending on the distribution network. Following are the types of openings:

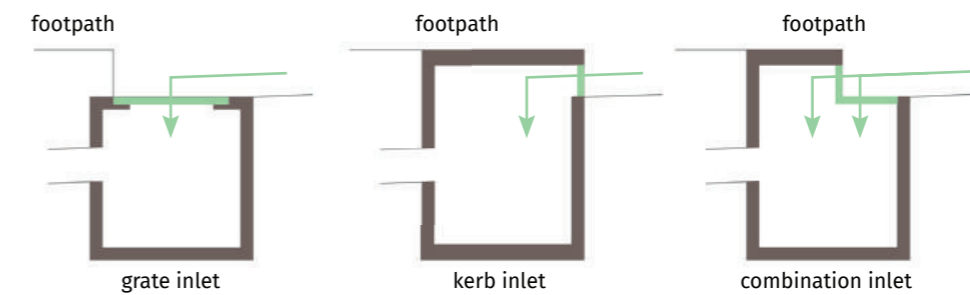

The openings can be into catchpits or directly into the storm water drain, depending on the distribution network. Following are the types of openings:

Other types of catchpits with pervious bottoms can help in infiltration of water thus recharging groundwater. Gravel pits, bioswales, and other filtration techniques can also be used along with catchpits to remove silt and pollutants before releasing the stormwater into the drainage system.



Fig. Manhole with catchment pit opening in DP Road, Pune

B electrical

Electrical lines include low and high tension cables which carry power to properties and transformers respectively, overhead cables, connections to streetlights, surveillance cameras, and utility boxes/RMU units. To prevent digging of the footpath in the future, it is advisable to shift overhead high tension cables underground before or during the street construction project, and also provide additional ducts to accommodate new lines later.

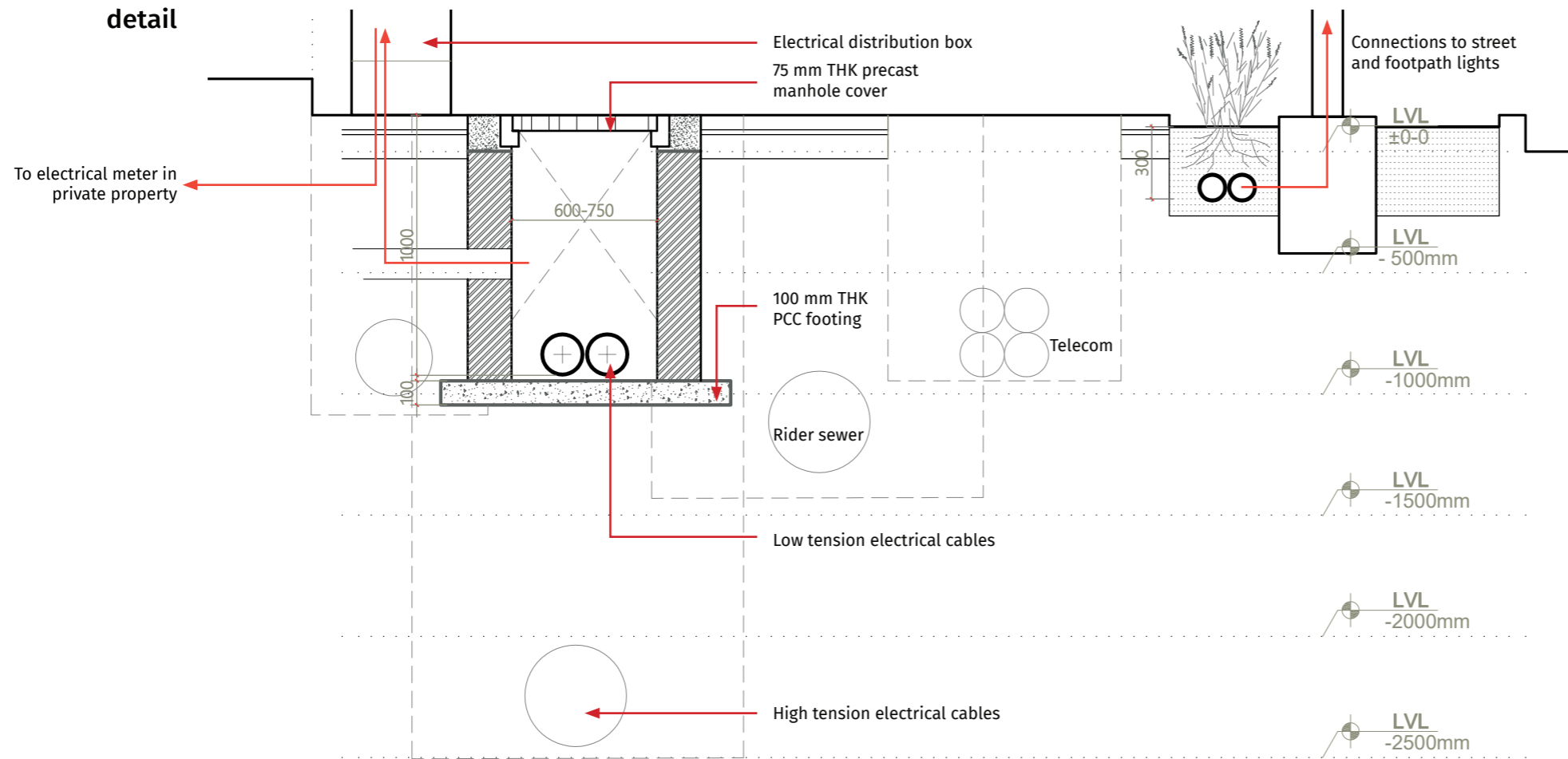

key section

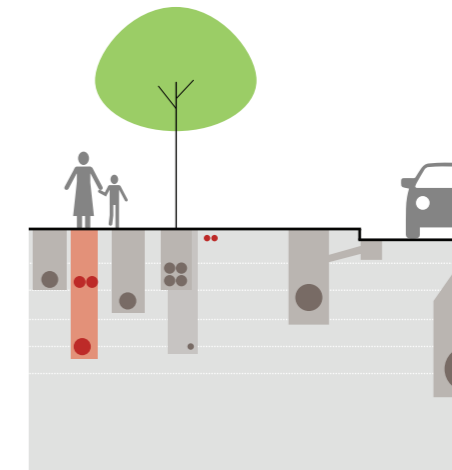

preferred location

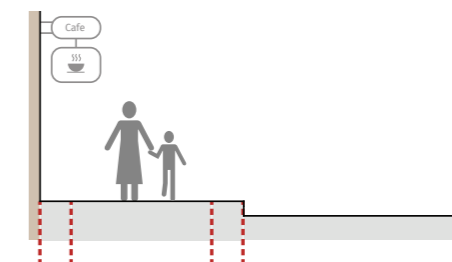

location
Along property edge or kerbside, so utility boxes can be placed at the edge without obstructing the footpath



relation to other utilities
Not close to water supply lines, to avoid short circuit

aboveground infrastructure
The detailed drawing for electrical utilities should show the location of distribution boxes above the ground.

ducts recommended
Ducts should be preferred for electrical cables since trenches lead to conflicts where utilities cross over each other and also collect water over time proving harmful to the cables.

bundling of cables
Cables for streetlights, surveillance cameras, etc. are small enough to be bundled and buried directly in the planter zone at the edge of the footpath, eliminating the need for manholes and deep digging.

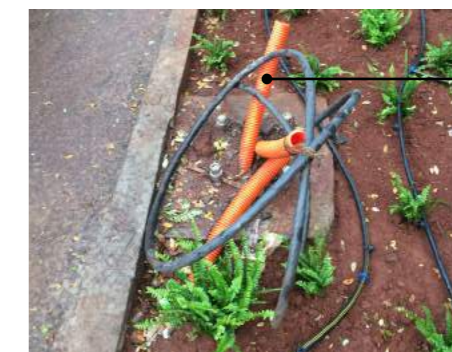

cables for streetlights and other fixtures (surveillance, signages, sensors, and signals)



Fig. (above)
Typical section across electrical manhole

Fig. (below)
Ducts with electrical cables in DP Road, Pune

C telecommunication

Telecom lines include CATV/VI cables, optical fibre cables, conventional copper cables and connections for surveillance & security units. Common manholes should be provided for lines run by both public and private telecom operators, such that the ducts are not disturbed during maintenance.

detail

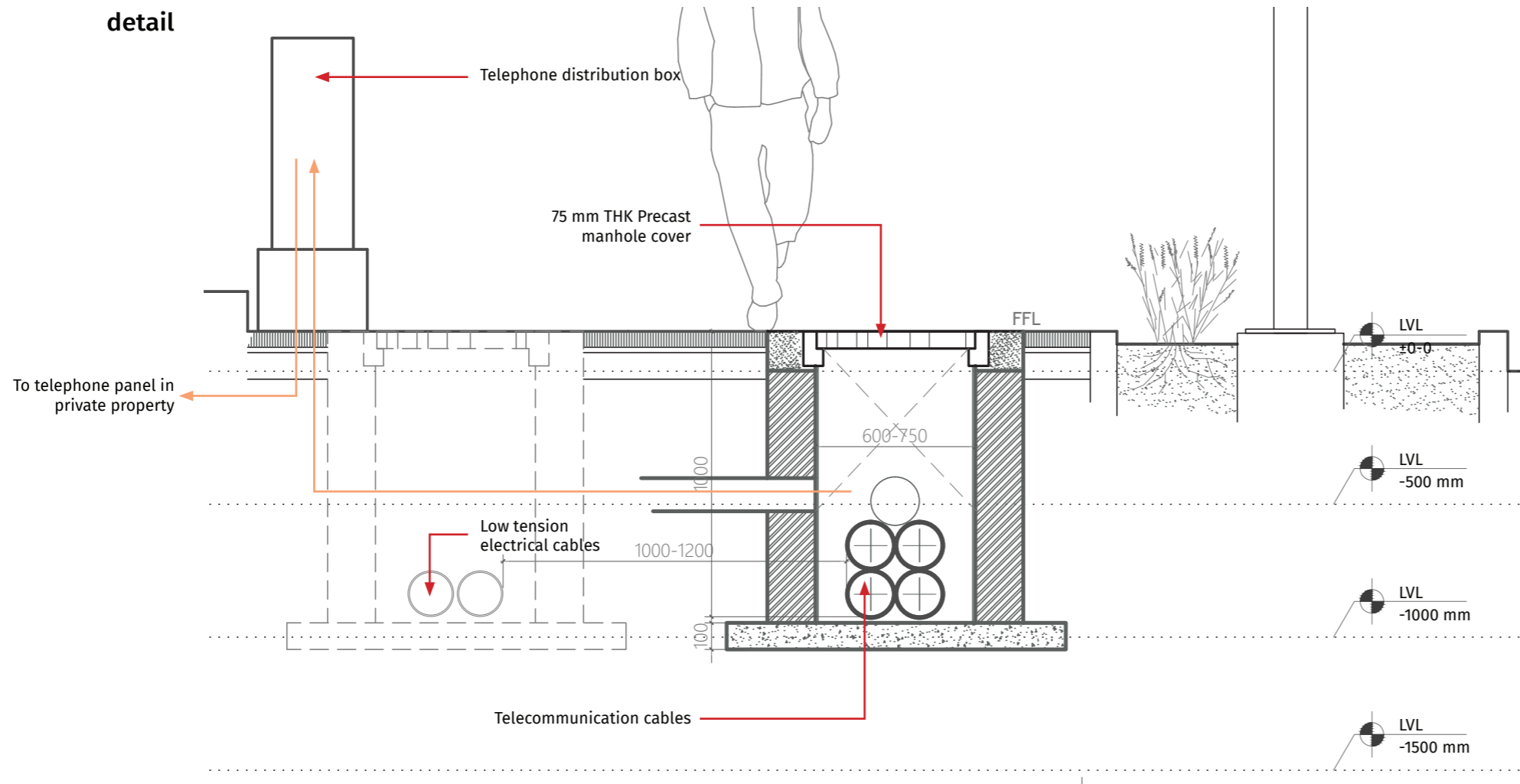

key section

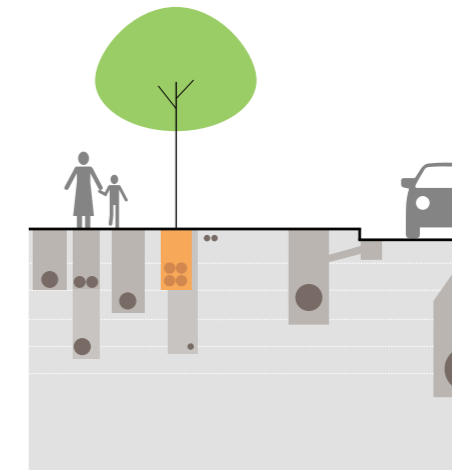

preferred location

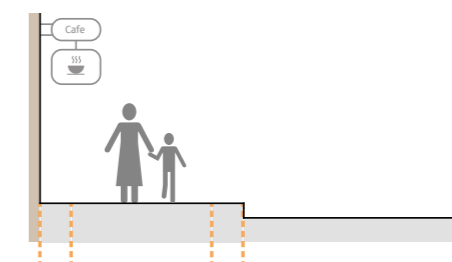

location
Along property edge or kerbside, so utility boxes can be placed at the edge without obstructing the footpath



location
Copper telecom cables should not be placed close to electric cables to avoid electrical interference due to induced voltage.

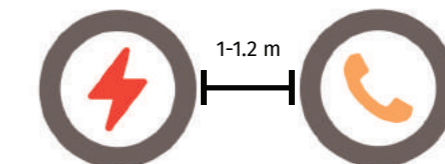

relation to other utilities
A min distance of 1-1.2 m should be provided between the two to avoid magnetic induction (in case of conventional copper cables).

Fig. (above)
Typical section across telecom manhole

Fig. (below left)
Manhole for telecommunication ducts in DP Road, Pune



Fig. (below right)
Distribution boxes connected with manhole and placed near property edge parallel to the kerb line in Tilak Road, Pune

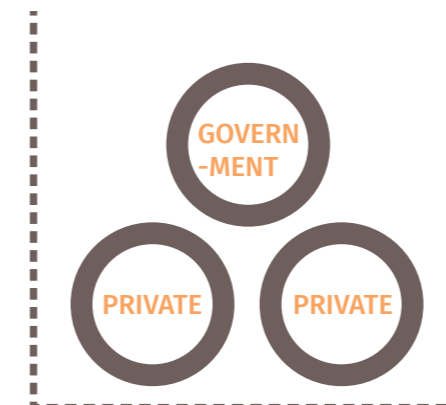

stacking of ducts
Lines run by government and private operators can be stacked, and accessed through a single manhole.

D sewer

Sewer lines carry greywater and blackwater from residential and industrial discharge. They comprise the main trunk line and the connecting rider lines. If the site conditions do not allow for a continuous rider line, a dummy/ buffer chamber could be provided to connect new sewer lines from private properties to the main sewer line. All drainage lines have gravitational flow and should have parallel alignment to road centreline.

detail

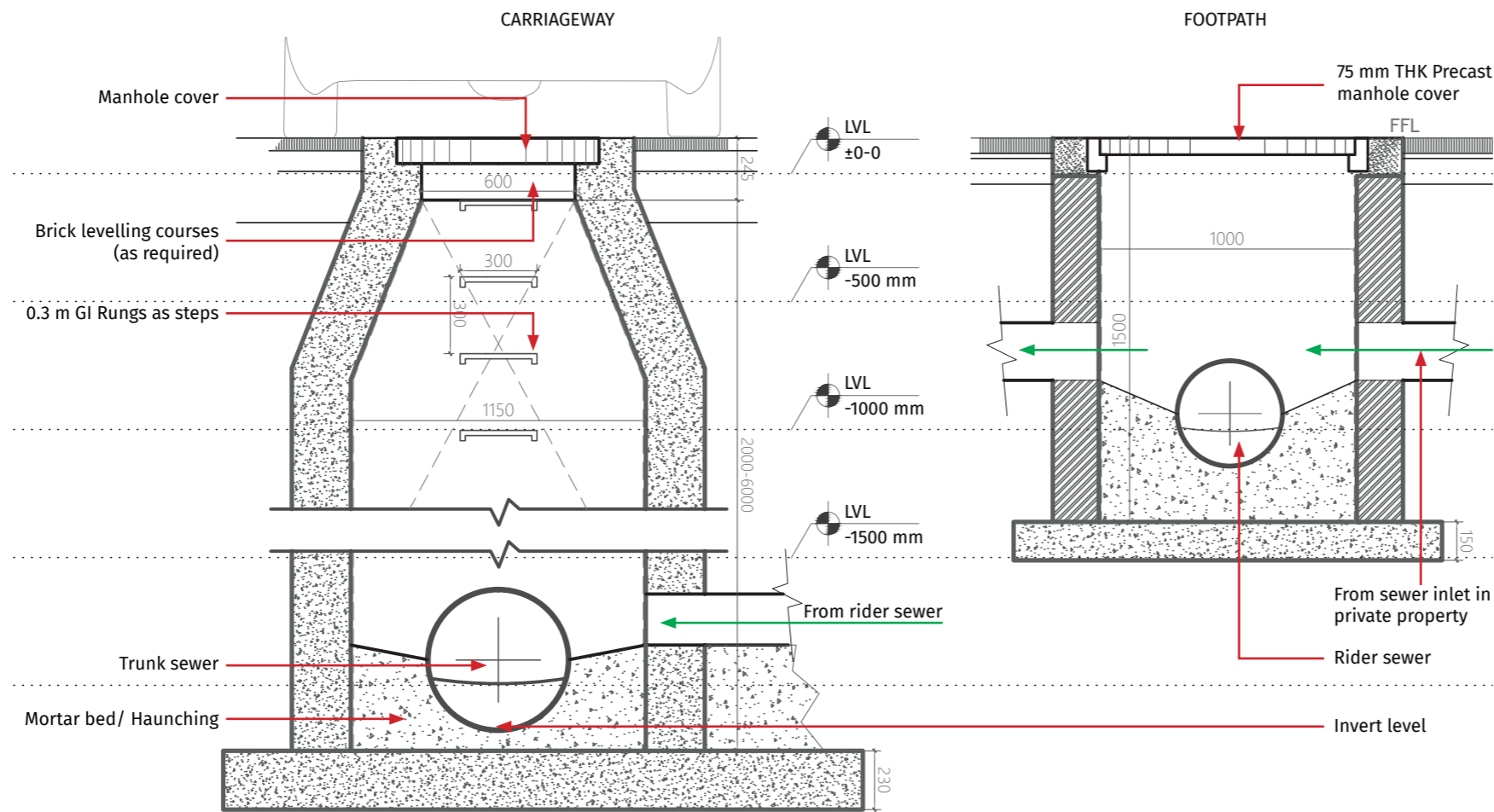

key section

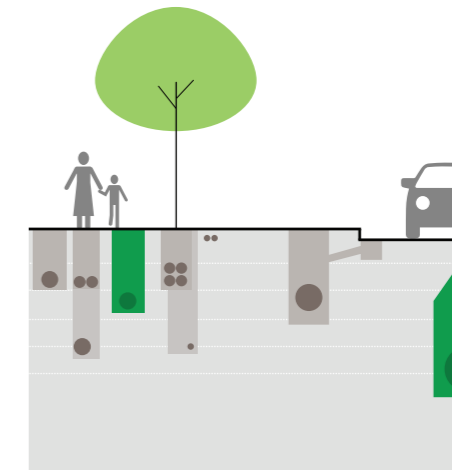

preferred location

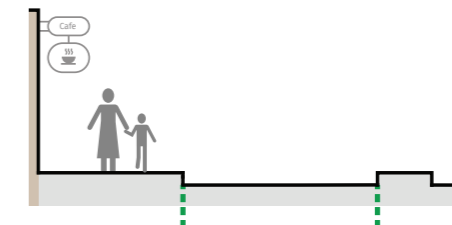

location

Trunk sewer lines should be located below the carriageway. Rider sewer lines should be located below the footpath.

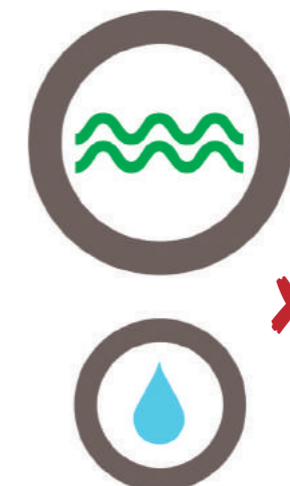

relation to other utilities

Rider sewer line should not be laid above water line, in order to avoid contamination of potable water with sewage water in case of a pipe burst.

Fig. (top)
Typical section across trunk sewer manhole and rider sewer manhole

Fig. (bottom left)
Construction of a conical manhole in DP Road, Pune

Fig. (bottom right)
Worker adjusting a manhole cover in DP Road, Pune



rider sewer

Provision of rider sewer results in shorter crossing distances. New connections can be made to the rider sewer, as it can have multiple such connections.

utility lines across carriageway

Where road crossing is necessary, the utility lines should be laid underground perpendicular to the alignment of the road. The construction should be strong enough to withstand the superimposed traffic loads and earth pressure.

E water

Water supply lines carry potable water under pressure, and can be placed on one or both sides of the carriageway. Chambers with control valves are generally provided before connecting the main supply to adjacent properties. Additional connections can be made in future from these control chambers.

key plan

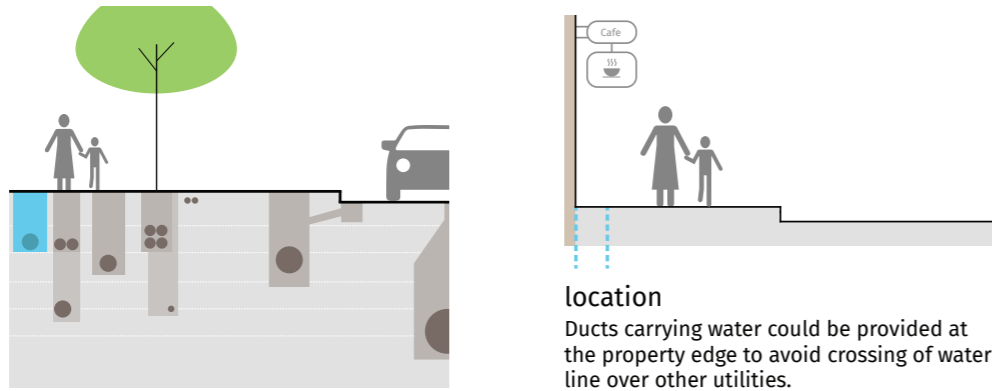

detail

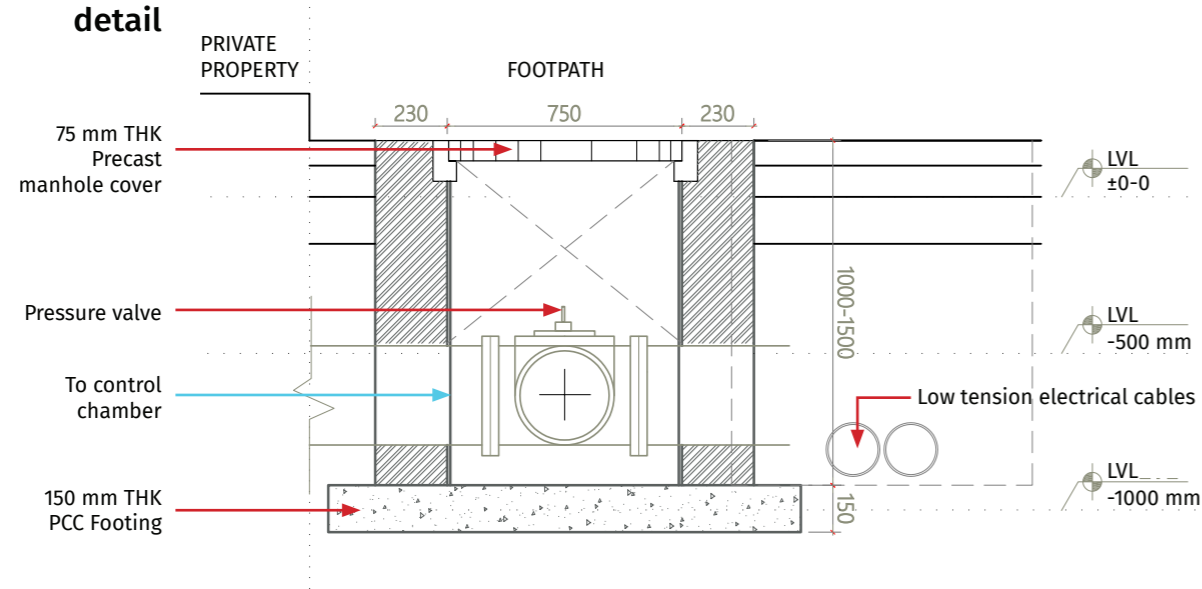

water line adjacent to sewer line
Horizontal clearance of 3 m should be maintained between water and sewer lines to avoid contamination of the water line in case of leakage.

water line above sewer line
In case of lack of space, water line should be placed above the sewer line with vertical and horizontal clearances of 0.5 m and 1.5 m respectively.

Fig. Typical section across manhole for potable water

gas F

Gas mains and other ducts carrying combustible material should have clear visible markers above the ground. These markers should denote the type, location and date of installation with emergency contact numbers. The guidelines for these utilities should be strictly followed under expert supervision.



Fig. (left) Gas mains and utilities carrying combustible material

Fig. (right) Signage during repairs or laying of gas pipes

Other guidelines

In case of lack of adequate space, dry utilities like telecommunication, electricity, etc. can be consolidated and stacked together to minimize the space occupied. Permissions from respective agencies must be obtained before consolidation. Manholes must be provided at regular intervals for ease of access and maintenance. Common manholes can be used for government and private connections with proper stacking of utilities.

Abandoned ducts and trenches should be reused or consolidated if duplicate or defunct lines are discovered during utility mapping. On-site engineers and the respective utility agencies should be contacted for re-routing. The decision to reuse or retrofit existing lines should be taken by the engineers based on their conditions and cost-effectiveness.

Additional empty ducts should be provided which can be used in the future for new connections or different utilities avoiding the need for unnecessary excavation.

Identification systems for underground utilities and crossings on the footpath should be established. These may be in the form of colour coded chamber covers or other similar marks which will make it easier to locate later.

consolidation

abandoned lines

future demand

identification system

2.2.2.D utility bed and backfilling

utility bed

Once the position, number, carrier type, depth, and design of utilities are finalised, the bed for these utilities should be prepared accordingly. The excavated area should be levelled and compacted before laying the lines, as per IRC-36:2010*. The bed should be made of PCC in the case of soft soil, or a layer of granular material free of stone fragments.



backfilling

After the utilities are in place and checked for watertightness, the pit should be refilled and compacted using suitable compaction equipment such as walk-behind roller, rammer or plate compactor as directed by the engineer according to MoRTH section 301.3**. Utmost care should be taken to ensure that no damage is caused to the ducts and other permanent work. Each layer should be watered to assist in consolidation and compaction.



Fig. (top)
Utility bed preparation and backfilling in FC Road, Pune

Fig. (bottom left)
Heavy roller for compacting surfaces without utilities beneath, as seen in University Road, Pune

Fig. (bottom right)
Walk-behind roller compactor in case of utilities underneath, as seen in FC Road, Pune

preparation of sub base 2.2.2.E

After compaction of soil, a granular sub-base (GSB) of 100-150 mm height is constructed usually upto the carriageway level, with well-graded granular soil. Grit can be used additionally to adjust the height of the footpath to the required 150 mm (including the courses above ground level).

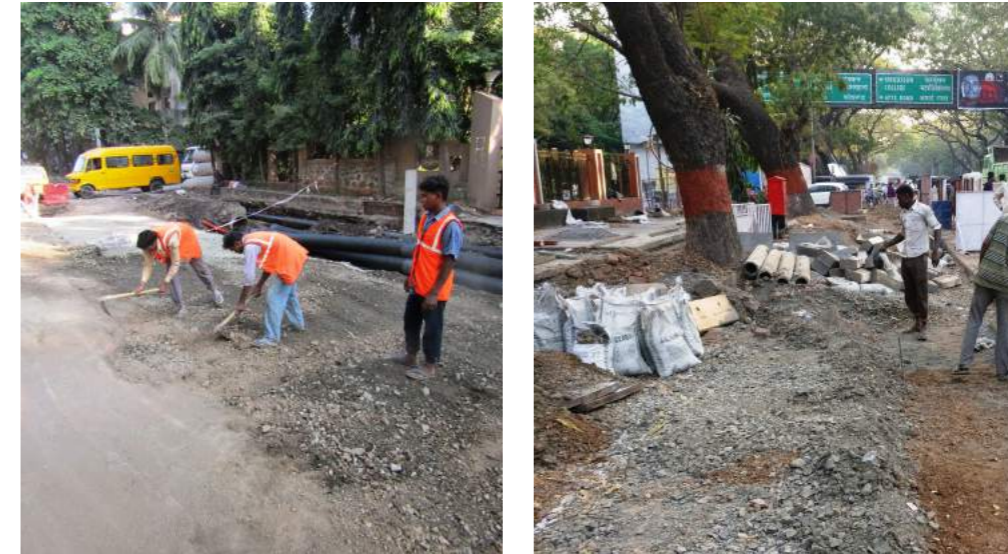

Fig. (top left)
Workers manually levelling the granular sub-base in DP Road, Pune

Fig. (top right)
Sub-base under construction in JM Road, Pune

Fig.
Alignment lines are drawn to mark the kerb, cycle track, pedestrian, and green zones

* IRC-36:2010- Recommended Practice for Construction of Earth Embankments and Sub-Grade for Road Works

** MoRTH section 301.3: Earthwork, Erosion Control and Drainage (Backfilling)

2.2.3 above ground construction

quality and workmanship

The quality and workmanship should be the prime responsibility of the Site Engineer/ Consultant/ Municipal Engineer. The engineers need to be extra vigilant about the quality of material and workmanship standards to ensure long lasting infrastructure. The contractor should deploy different teams for different work sets.

a laying of kerb stones

The final finished height of the footpath is marked by placing kerb stones along the edge. Pre-fabricated kerb stones are generally preferred over as they are stronger, easy to install, and have uniform finish. However, in some cases in-situ construction of kerb stones can be done if the site has numerous obstructions like trees.

step 01 The top level of the kerb stone and the manhole cover should align with the final finished footpath level. They should not exceed 150mm.



step 02 Kerb stones for parking spaces and bulbouts should be placed according to the design. Curved and angular blocks can be used to create such spaces.



Fig. (above)
Alignment of kerb stones as per design in JM Road, Pune

Fig. (below)
Positioning the kerb as per design for cycle track, footpath, and bulbouts in FC Road, Pune



Fig. (above)
Kerb stones are carefully placed over PCC mortar base maintaining the alignment and height in FC Road, Pune

Fig. (below)
Positioning of kerb stones according to bulbouts in DP Road, Pune

* MoRTH section 301.3: Earthwork, Erosion Control and Drainage (Backfilling)

Saucer drains and openings to catchment pits should be laid along the footpath kerb to channelise and collect stormwater runoff. Saucer drains can also be provided along with the kerb stone as a single unit.

typical 150 mm THK kerb block

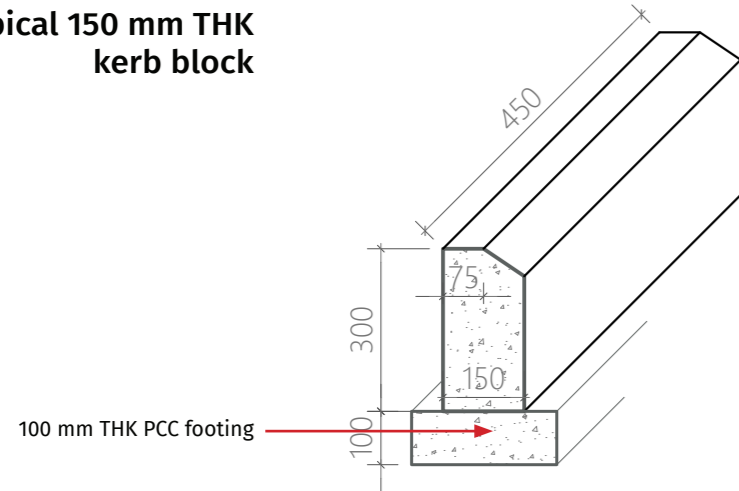

kerb block with saucer drain

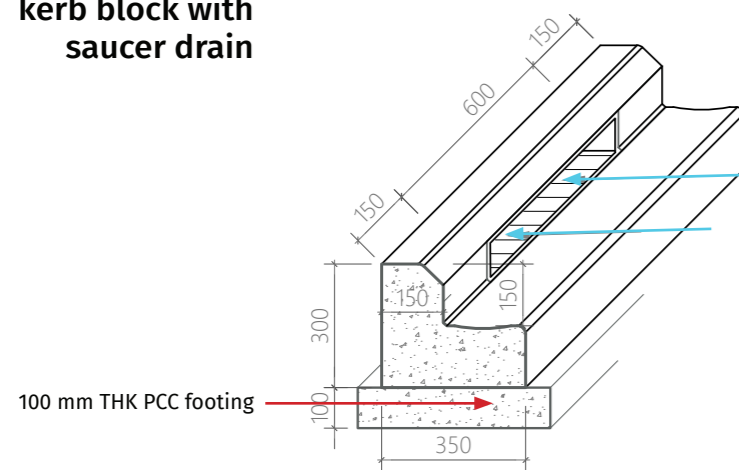

Fig. (bottom left)
Special precast rounded kerb stones of desired radii can be used for intersections and parking lots



Fig. (bottom right)
In-situ casting of kerb stones in special cases around utilities or trees as seen in University Road, Pune

base preparation b

Once the kerbstones are laid/ built in place, the basework* for the surface can begin. The thickness of the base layer would depend on the use of surface like cycle track, footpath, and parking. Tactile pavers are to be laid before the PCC/base work for the footpath.



base course

A PCC layer of minimum 100 mm thickness (M15 for pedestrian, M30 for vehicular) is laid as base course.



tactile pavers

In case of PCC finish, the tactile pavers are first fixed on cement mortar, after which PCC is poured around.

PCC finish



base course

A minimum 100 mm thick compacted layer of coarse aggregate is laid within the kerb stone line, as base course for flexible paving.

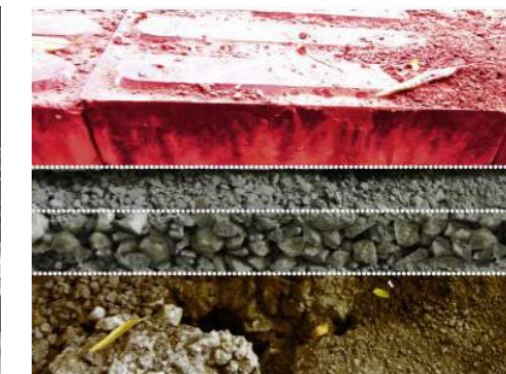

layers

The sub base and base courses should be sufficiently compacted and stabilized to prevent sagging in future.

paver blocks



Fig.
Paving tiles/blocks are laid on the compacted base to finish the footpath. This requires fine workmanship to ensure that the blocks are laid close together and do not come loose in the future.

* MoRTH section 500: Base and Surface Courses (Bituminous)
MoRTH Section 400: Sub-Base, Bases (Not-Bituminous and Shoulders)

c street fixtures

It is recommended that street fixtures* like bus shelters, utility boxes, trellises, seating, bollards, public toilets, bins, etc. are installed prior to the paving of the footpath. If not, provisions have to be made to install them later.

trees and landscape

For both proposed and existing trees, the girth and root system need to be considered while providing the pit and grating. The type of tree or shrub to be planted would depend on the location like median, kerbside buffer, tree pit, and bulb outs.

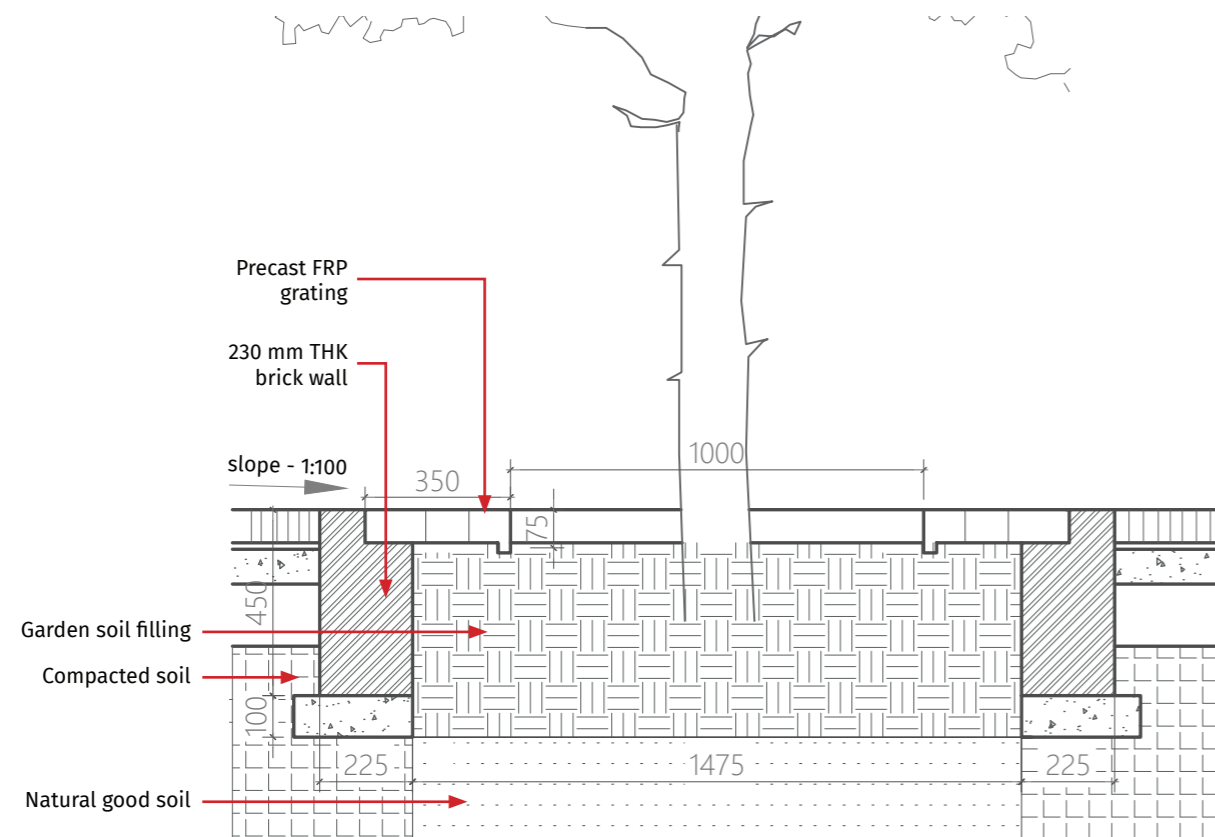

Fig. (top)
Section of a tree pit

Fig. (bottom left)
Sprinkler system

Fig. (bottom right)
Tree grating

* For placement & design of street fixtures refer to ITDP's "Footpath Design: A guide to creating footpath"

bus shelters

The footing of the bus shelter unit should be fixed before the PCC work of the footpath around it. A safe temporary waiting space should be provided for commuters until work is completed along that stretch.



bollards

Bollards should be installed as per design, firmly and perpendicular to the footpath surface. Bollards should have reflective strips to improve visibility. A series of pits is created and left for bollards while preparing the basework for footpath. The bollards can then be fixed at later stages to produce a neater finish.

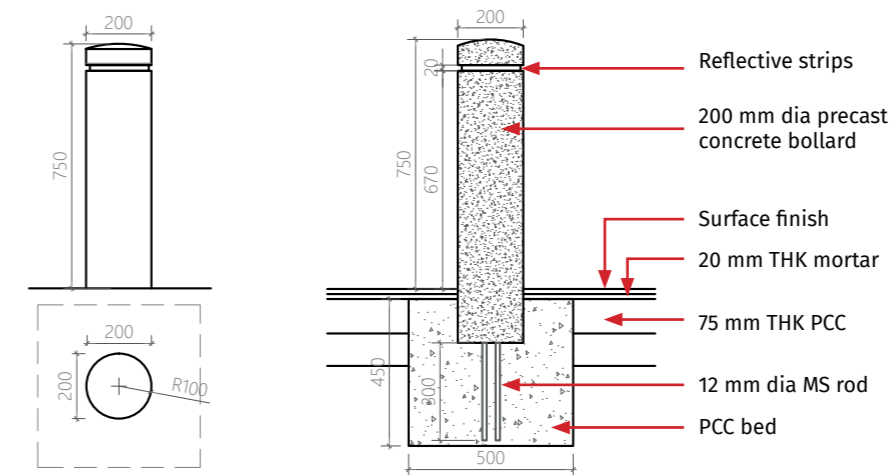

Fig. (top)
Fixing of bus shelter in Pune

Fig. (middle)
Plan, elevation and section of a bollard

Fig. (bottom left and right)
Steps involved in fixing bollards

seating arrangements

Infrastructure for seating needs to be constructed or installed as per the design proposal. Seating arrangements could be made with random rubble masonry around trees, with concrete as stand-alone structures or with pre-fabricated benches.



Fig. (top left)
Simple precast concrete units

Fig. (top right)
In-situ stone masonry around tree pits as seaters

Fig. (bottom left)
Cast in-situ RCC seating

Fig. (bottom right)
Prefabricated cast iron/steel benches to enhance identity of place

lamp posts

Footpath elements which have a footing are installed while concreting, along with electrical connections if necessary (for streetlights, surveillance units, etc.). The footing of the post is constructed before providing the PCC base for the footpath. The elements are then erected on the baseplates provided on the footings.

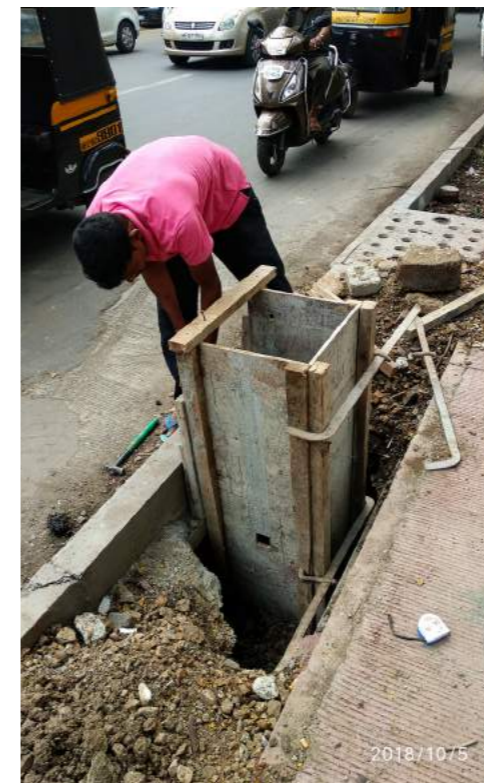
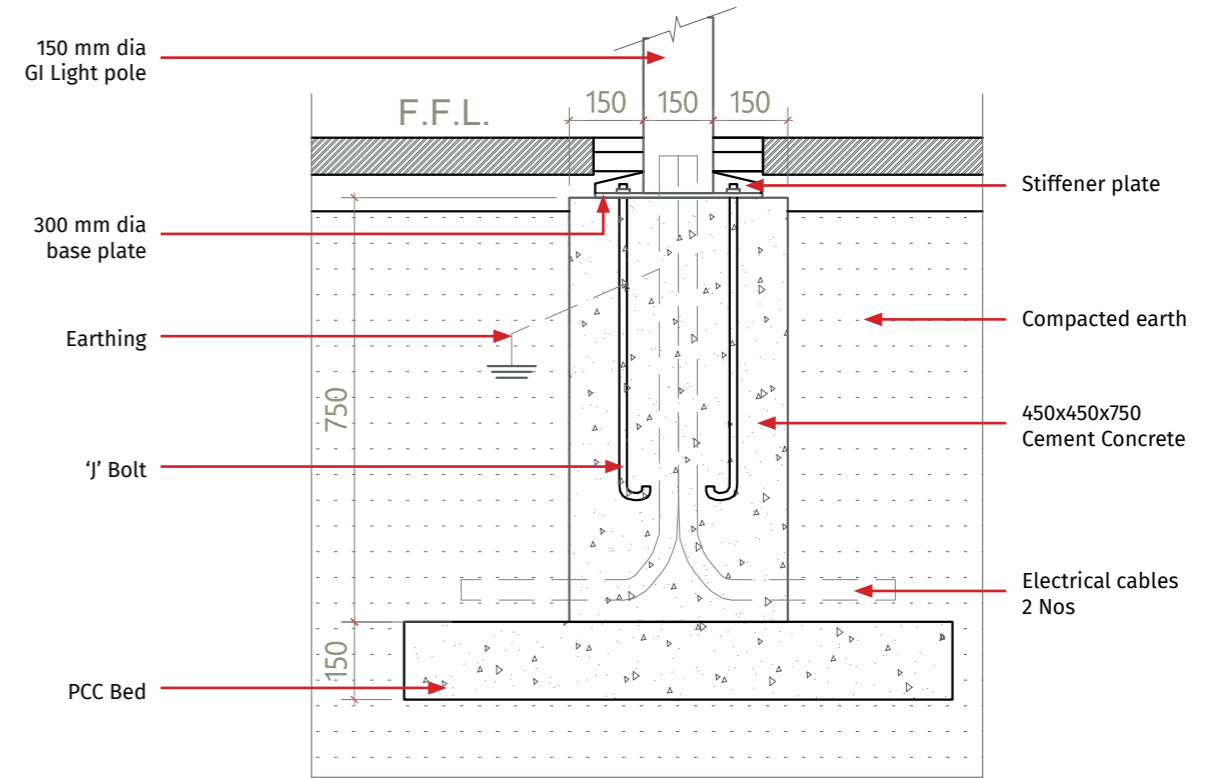

Fig. (top)
Section through the footing of a lamp post

Fig. (bottom left)
Formwork for the footing

Fig. (bottom right)
The footing, after completion

d surface finish for footpath and cycle track

The footpath can be finished with paver blocks or PCC. The finished surface should match with the level of manhole covers and kerb stones at 150 mm above carriageway level. Different textures can be used to mark different usages on the footpath. Paving should be avoided for cycle tracks; broom-finished PCC or stamped concrete is suggested for smoother cycle-riding experience as it provides an anti-skid surface. The cycle track surface can be pigmented to distinguish them from other surfaces.



Fig. (top)
Different surface finishes for different uses

Fig. (bottom left)
Broom finish for cycle tracks in FC Road, Pune

Fig. (bottom right)
Broom finished pigmented surface for cycle track

A 20-40 mm thick bedding course of fine aggregate should be laid prior to pavers; this will compact slightly to create a firm & flexible base for pavers.

paver blocks/tiles

Eg: Natural stone pavers (Stone slabs, stone tiles, cobblestones etc), Concrete pavers (Interlocking cement concrete block pavement-ICCBP), perforated blocks, Concrete pavers etc)

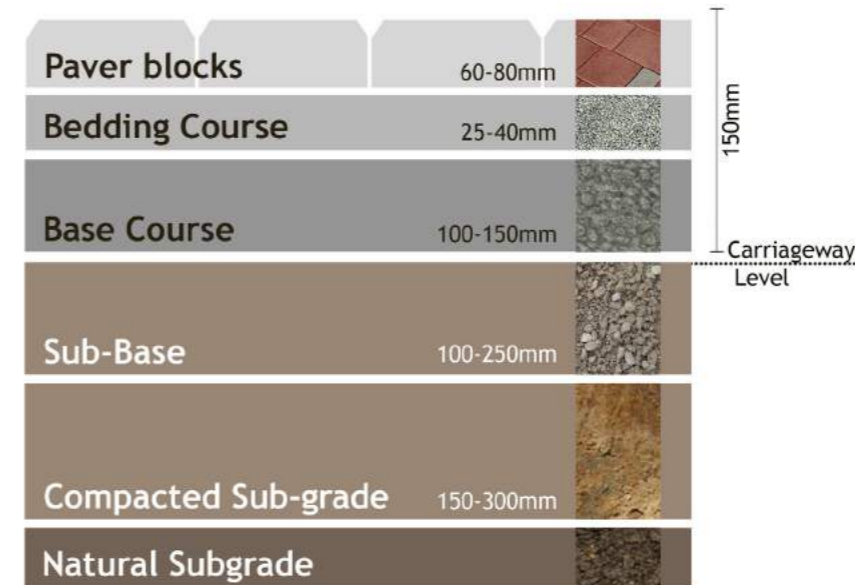

A binder course of 50-100 mm should be laid on the base course, over which the final surface course of 20-40 mm can be laid. The stamped/ pigmented concrete work should be sufficiently cured.

PCC finish

Eg: Textured, pigmented, stamped

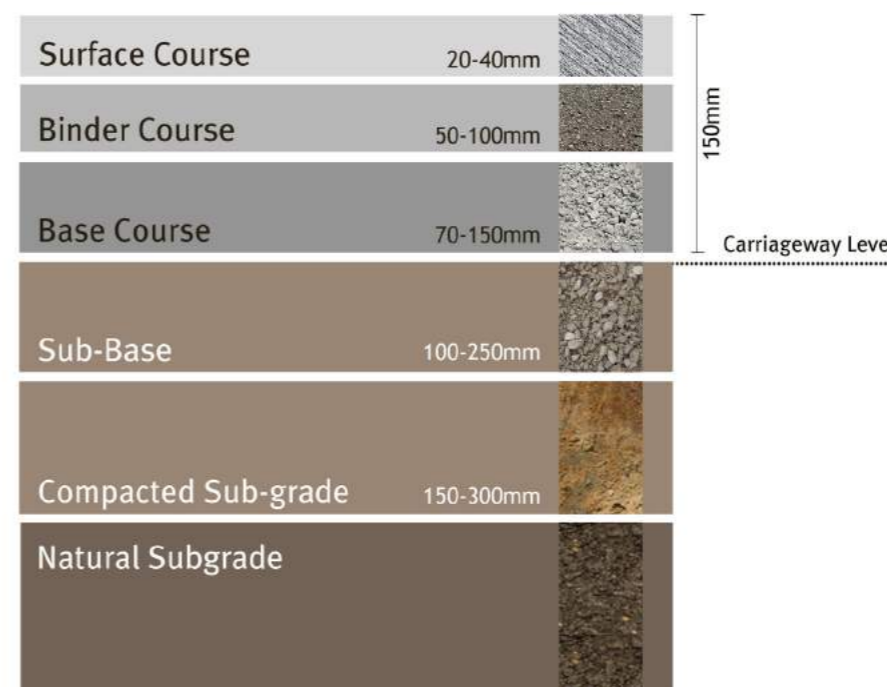

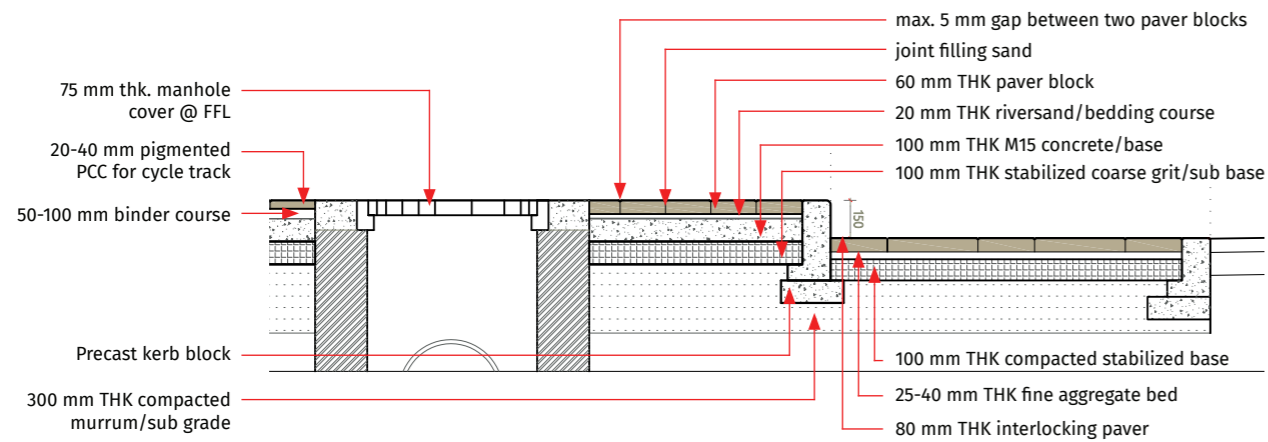

finish for parking spaces

Parking spaces can be finished with concrete (pigmented/textured/stamped) or paver blocks. They should be in the same level as the carriageway, albeit visually different. The final finish should be anti-skid, strong enough to withstand the load of vehicles, and should be even. Kerbstones are a must for parking spaces as they offer restraint to the pavement preventing it from dislodging. Concrete of grade M30-M40 should be used to take the load of vehicles.

Interlocking pavers are easy to dismantle in case of future repairs. A porous base helps in water percolation. A comfortable slope should be maintained to enable the drainage of water. The sub-base and base should be firmly compacted to avoid uneven levelling and liquefaction over a period of time. For effective water percolation, porous concrete blocks can be used. These blocks can also be used at property entrances and tabletops.

In case of soft soil, it is preferable to have a PCC base (preferably perforated concrete) to avoid uneven levelling of paver blocks.



Fig. (top)
Detailed section across paver blocks

Fig. (middle)
Cycle tracks should have concrete surface finish. For even finish, paver blocks must be avoided on cycle tracks

Fig. (bottom)
Dislocation of paver blocks due to poorly laid edge restraint i.e kerbs

Fig. (top)
Firm compaction of sub-base

Fig. (bottom left & right)
Porous parking finish

e construction of ramps

Construction of ramps for property entrances, at-grade crossings and intersections should be as per the design and IRC specifications unless otherwise approved by on-site engineer. Sufficient slope (1:20) and width should be provided for easy use by wheelchairs and prams. Flaring of ramps should be carried out only if the contractor has skilled labour to execute it. Alternatively, single sloped ramps can be provided. The kerbing required for ramps can be constructed in situ to manage the slope of ramps. The access points of ramps for crossings should have appropriate directional and warning tactile paving for the visually impaired and differently abled individuals.



Fig. (top)
Property ramp with flaring on both sides



Fig. (bottom)
Single slope property entrance ramp with bollards under construction in ITI Road, Pune

Building a Small Concrete Ramp | YouTube
<https://www.youtube.com/watch?v=pEIPemDHfOw>

f other street elements

Other street elements* like cycle racks, play equipment, advertising boards, garbage bins, beautification elements, etc., can be added as per design at this stage. Their placement has to conform to IRC-103-2012: Guidelines For Pedestrian Facilities.

While provisions for footing have to be made at this stage, the equipments can be installed later, after the completion of surface work.



Fig. (top left)
Open gym in Kasarwadi, Pune

Fig. (top right)
Cycle rack

Fig. (bottom left)
Utility box enclosed in attractive casing

Fig. (bottom right)
Dust bin

* For placement & design of street fixtures, refer to ITDP's "Footpath Design: A guide to creating footpath"

2.3 construction of carriageway

introduction In many cases across India, the complete streets redevelopment proposals might only involve execution of footpath (as a footpath widening project, footpath retrofitting or NMT projects) and might not involve entire carriageway re-construction. In such cases; if the existing camber permits, only the carriageway width required for footpath widening would be tilled and reconstructed. This chapter covers basic construction steps for carriageway construction. It also covers painting and signages as the last part of execution of complete street.

basic principles

drainage carriageway should have proper longitudinal gradient (minimum 0.3 %) and camber (1.5 to 2.5 %) to allow for surface runoff.

surface even surface with level difference of top coat of carriageway and kerb of 150mm

Construction in layers compacted subgrade with solid base and strengthened surface

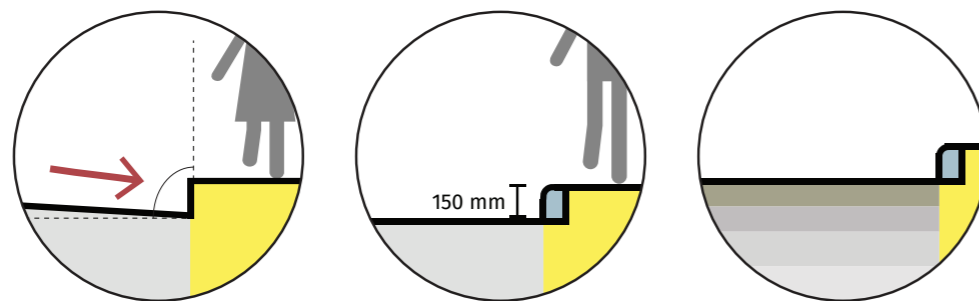

Fig. Carriageway components in DP Road, Pune

pavement types

Rigid pavements have high flexural stiffness and consist of three primary layers i.e. sub-grade, base course and concrete slab.

rigid pavement

Flexible pavements have low flexural stiffness and consist of four primary layers i.e. subgrade, sub-base, base course, and asphalt. Further, flexible pavements also have prime coat and tack coat applied within the structure of pavement.

flexible pavement

While rigid pavements are long lasting and preferred in roads with drainage problems and high traffic intensity, the advantage with flexible pavement is that they can be constructed in stages and have less carbon footprint.

However, the choice of type of a pavement is governed by the type of traffic and soil conditions.

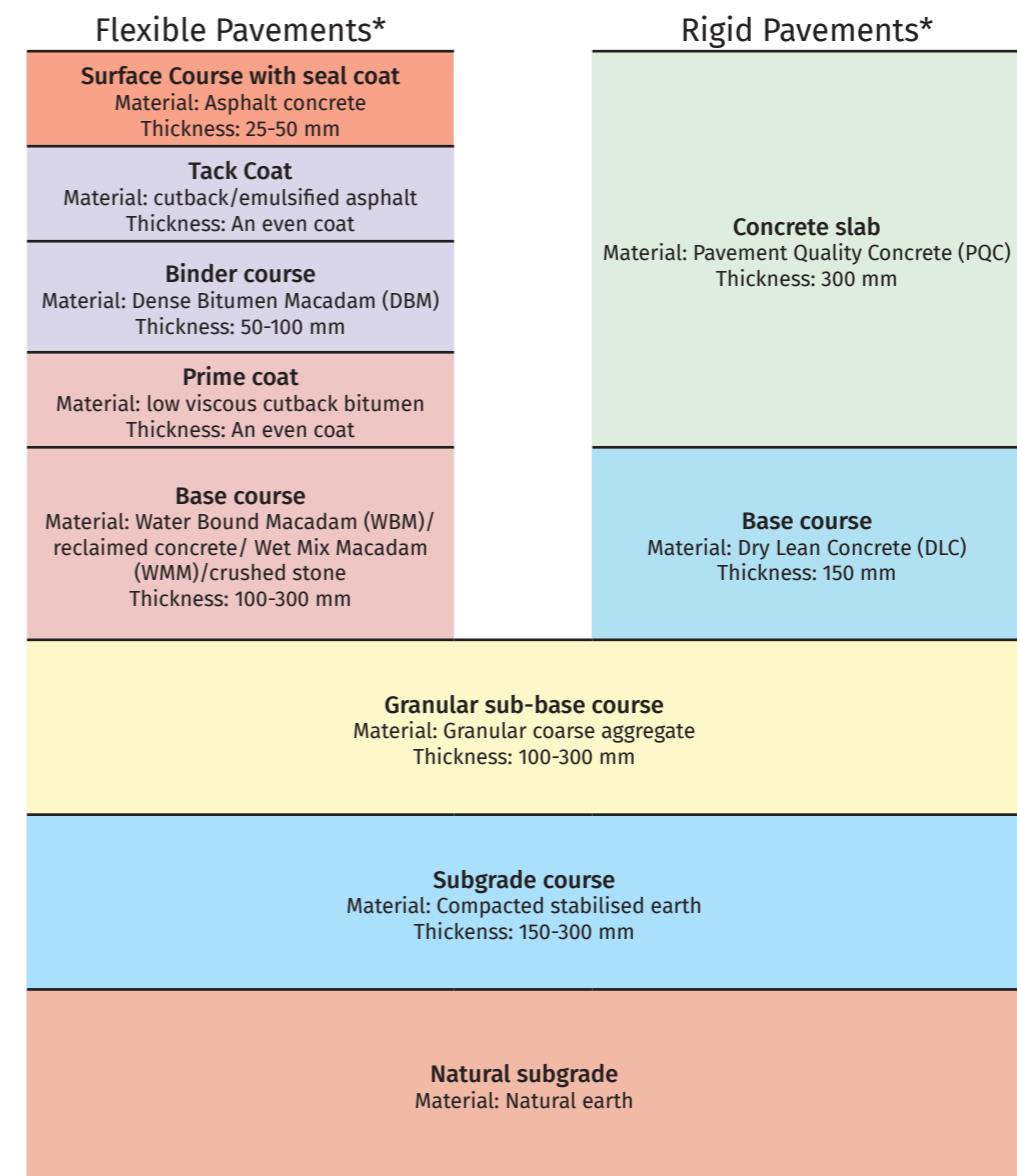

Fig. Layer composition of flexible and rigid pavements

* IRC: 37-2012: Design of Flexible pavements

relaying of existing asphalt road

Surface should be scarified and reshaped to the required grade, camber, and shape. This is followed by the removal of depressions and potholes. A single coat of low viscosity liquid bituminous material should be applied to existing bituminous cement concrete or primed granular surface as instructed by the engineer.

Premixed hotmix material as per the approved mix design and thickness is then laid with the paver finisher. Compaction should be carried out using vibratory equipment starting from edge and moving towards the centre. Adequate efforts should be taken to avoid poor joint construction. Routine checks should be carried out at site to ensure the quality* of the resulting pavement mixture and the pavement surface.



Fig. (above)
Tilling of carriageway in FC
Road, Pune

Fig. (below)
Road laying in DP Road,
Pune

* IRC SP 057: Guidelines for Quality Systems for Road Construction, IRC SP 112-2017
Quality Control for Roads and Bridges

median and islands

The median, if raised, shall be raised at least 300 mm by using kerb stones of approved material and dimensions and suitably finished. If the median includes landscaping, the details are to be followed as per the advice of architects and engineers.

The refuge island should either be raised to 150 mm to match the table top level or should be levelled with the carriageway. Bollards and markers should be used to prevent vehicular entries onto the islands while ensuring access to wheelchairs, prams, and cyclists.

The islands should be wide enough to accommodate these users, have proper lighting, retro-reflective markers, and appropriate signages.

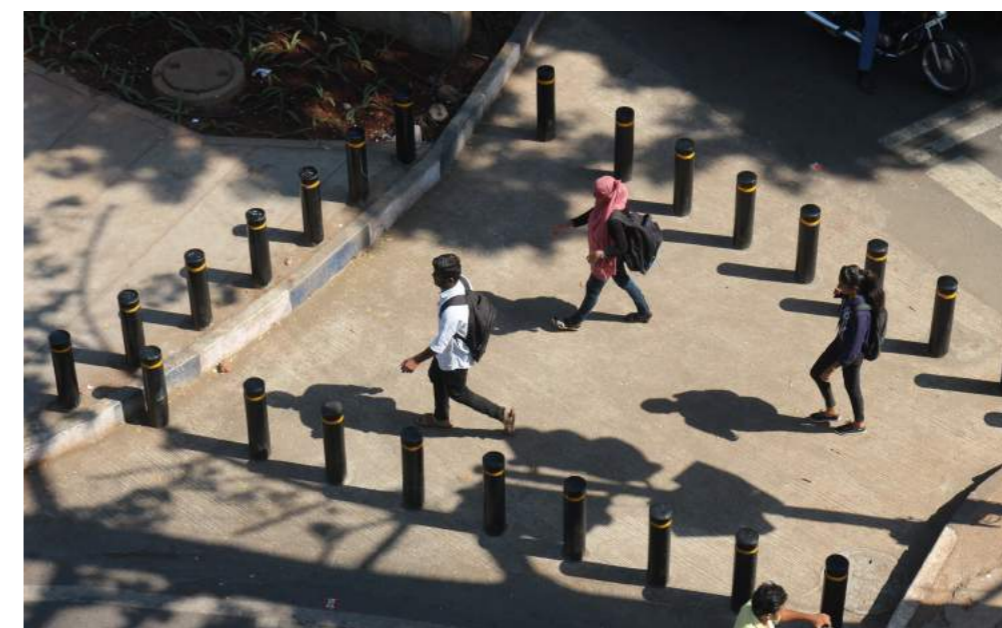

Fig. (above)
Tabletop crossing in DP
Road, Pune

Fig. (below)
Refuge island in JM Road,
Pune

construction of tabletops

steps for construction

- Preparation of lean concrete base to provide concrete/ paver block surfacing.
- Provision of metallic edge support elements to confine the table top surface.
- Laying of the surfacing/ concrete/ paver blocks.
- Compaction of the paver blocks and surfaces.
- Provision of concrete ramps on both side of the table top crossing. Higher grade concrete (M30 and above), should be preferred.
- Provision for draining stormwater by providing catchment pits before tabletops or allowing it to flow through pipes in the tabletops. As an alternative, a small gap covered with grills can be provided between the tabletop and the footpath.



Fig. (top)
Tabletop crossing in DP
Road, Pune

Fig. (bottom left)
Culvert across a tabletop
with metal grill in Chennai

Fig. (bottom right)
Catchment pits provided on
either side of the table
for access to stormwater drain
in DP Road, Pune



painting and marking

As the final step, after all installations and finishes, lanes should be marked with either water-based or thermo-plastic paints and must adhere to IRC 35- 1997 for road markings and MoUD IUT Code of Practice for road markings or Clause 803 of MoRT&H specifications.

Raised Pavement Markers (Cat's Eyes), road studs, reflective posts are used to form a semi-permanent or fixed based marking to provide improved visibility during night time and wet-weather conditions. These shall be provided at hazardous locations and while approaching important intersections.

The cycle track, pedestrian crossing, etc. should have clear markings as per standards. Locations of signs, road delineators, overhead traffic signs shall conform to IRC:67:2001, IRC: 35:1997, UTTIPEC: guidelines for road markings, and Section 800 of MoRTH Specifications. The traffic signal, its configuration, size, and location shall be in accordance with IRC: 93 and IS: 7537 or as directed by the Engineer.



Fig. (top)
Thermoplastic road
marking in Nigdi, Pune

Fig. (bottom)
Lane marking on cycle
tracks in Pune; Lane
marking on cycle tracks
should be painted every 6
months for better visibility.



3

POST CONSTRUCTION PROCESS

maintenance manual | maintenance by contract

3.1 maintenance manual

maintenance manual

Routine maintenance work includes several small tasks. It may not be possible for the staff on ground to remember all of them. In addition, the newly inducted staff may not be aware of all the work involved in the maintenance of streets. Even if the staff is trained regularly in the activities related to maintenance, it is important that some reference book is available to the staff.

A maintenance manual should thus be prepared for guiding the staff, using the help of a consultant if necessary. This manual should list out every activity to be undertaken as part of the routine maintenance, along with step-by-step guidelines of the processes involved and the required equipments. It will also mention the frequency of inspections to be carried out by various officials.

Maintenance work is classified into two categories viz.
 (1) Routine maintenance (including minor repairs and regular cleaning)
 (2) Major work (including road strengthening, resurfacing, etc.)

Budget allocation and preparation of estimates should be done according to the category of work involved.

quality audits

Periodic quality audits of repair operations for carriageway and footpath should be carried out by Officers on Special Duty (O.S.D) and third parties not related to the maintenance work. This ensures effective monitoring and control. Various IRC and MoRTH guidelines are available for maintenance of pavement and carriageways. Audits for footpaths should be based on desired level of service, as mentioned in IRC.

complaint redressal

Municipal corporations should set up 24 hr helplines especially during monsoon seasons for attending to complaints related to water logging, fallen trees, debris, and other issues. Some corporations have set up websites for accepting complaints. The Junior Engineer (JE) of the respective areas is responsible for redressal of complaints within 48 hrs.



Fig.
Pune Municipal Corporation
24x7 maintenance vehicle
for quick repair; the
van is equipped with
bollards, tiles, paver
blocks, etc. Citizens can
lodge complaints online/
on mobile app and the
maintenance van staff fix it.

* Excerpts from STAC (Standing Technical Advisory Committee) Report, Pune Municipal Corporation
 ** MoRTH Guidelines for Maintenance Management of Primary, Secondary and Urban Roads

maintenance by contract 3.2

contracts for maintenance

The maintenance of roads is the responsibility of the corporation. The corporation generally carries out routine maintenance through contract, initially on a small scale and if successful, on a larger scale. The corporation can appoint a separate agency for maintenance or extend the scope of work of the construction contractor to include maintenance. It is necessary to draft the contract properly with accurate measurable performance criteria, so as to judge whether the contractor has performed his duties properly to become eligible for payment.

If the construction contractor is to be appointed for road maintenance as well, he should be made responsible for the work, for a minimum duration of five years. This would encourage him to use good quality material and better workmanship during construction for improved cost optimisation in the future.

The defect liability period and the duration of maintenance for such construction work should be explicitly mentioned in the contractor's tender. The contractor should provide supervising staff along with necessary skilled and unskilled labour for the works. They should repair any faults and maintain roads, landscape and utilities at an acceptable serviceability level, as directed by the engineer-in-charge during such period. After completion of the defect liability period, another agency can be hired for the maintenance of such streets.

It should be noted that during the defect liability period, the liability of the contractor is limited to rectification of defects in the construction work carried out by him. It should also be noted that this does not include routine maintenance of the infrastructure created. However, to avoid multiple agencies working on the same infrastructure during the contractor's defect liability period, it is suggested that the scope of the contractor's work should be extended to include regular maintenance and he be compensated accordingly.

Some of the activities covered under Operation and Maintenance include:

- Sidewalk/Plaza Maintenance: repairing, replacing, installing, and cleaning of paving and kerb, and landscape maintenance.
- Street/Road Repair and Maintenance: top coat repair, resurfacing and patching.
- Street/Road/Sidewalk cleaning: Sweeping and debris removal.
- Street furniture maintenance.

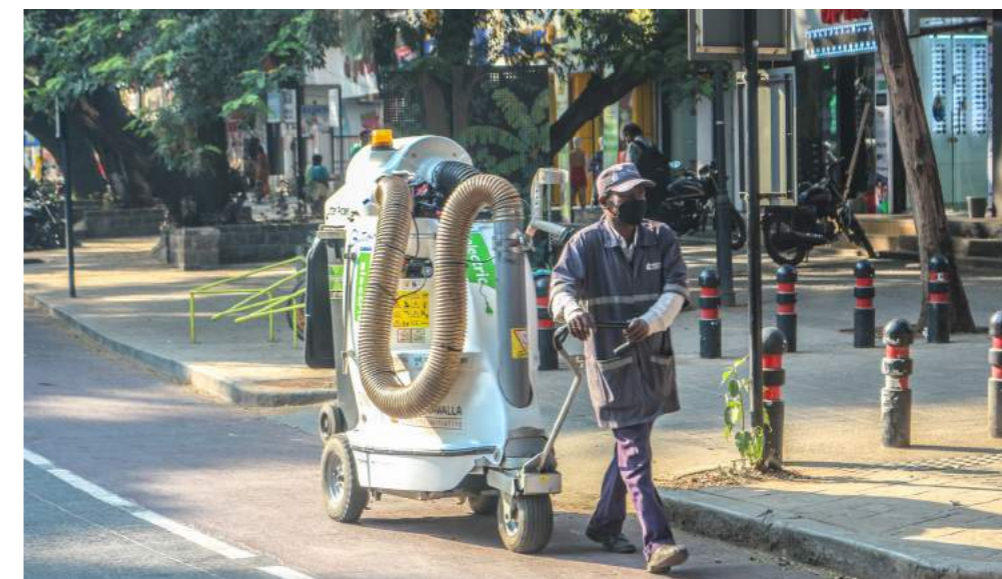

Fig.
Routine maintenance in DP
Road, Pune

defect liability

tasks for O&M



4

CONSTRUCTION
TIMELINE

construction timeline 4.0

The timeline for such works depends on the number of teams deployed by the contractor on site. The below-mentioned timeline is typical in urban areas for a stretch of 1km, assuming that separate teams are deployed by the contractor and all required permissions have been obtained. The estimated time periods are as follows:

estimated timeline

- Existing carriageway scarification – 3 to 4 days per km
- Excavation/ Utility connections/ relaying – 1 to 2 weeks depending upon the number of utilities being tackled
- Surfacing work – 2 to 3 days per km for 2 lane roads
- Footpath kerbing – 1 week per km
- Footpath base work – 2 weeks per km
- Footpath surfacing – 2 to 3 weeks per km depending upon the width
- Street furniture items – 2 to 3 weeks depending upon the number of items
- Markings / painting – 2 to 3 days per km

| Step | Week | | | | | | | |
|--|------|---|---|---|---|---|---|---|
| | 1 | 2 | 3 | 4 | 5 | 6 | 7 | 8 |
| Existing carriageway scarification | █ | | | | | | | |
| Excavations/ utility connections/ relaying | █ | █ | | | | | | |
| surfacing work 2 lane roads | | | █ | | | | | |
| footpath kerbing | | | █ | | | | | |
| Footpath base work | | | | █ | █ | | | |
| Footpath surfacing | | | | | █ | █ | █ | |
| Street furniture items | | | | | | █ | █ | █ |
| Markings/ painting | | | | | | | | █ |

Table 04:
Estimated construction timeline

ANNEXURES

request for proposals | list of references

request for proposal

for procurement of implementing agency for the execution of complete streets

01 qualification criteria for bidders

- Average annual turnover during last three years on Construction of Civil/Roads Works not less than 60% of the estimated cost of the project (excluding maintenance cost of the project).

- Experience of having successfully completed, during last five years, one similar work costing not less than the amount equal to 80% or two similar works each costing not less than the amount equal to 50% of the estimated cost (excluding maintenance cost of the project).

- Experience (shall be fulfilled by all Joint Venture members) in construction in all of the following categories:

Urban roads/streets, urban drains and other utilities, junction improvements, footpaths, and cycle tracks.

02 technical evaluation criteria

| No. | Description | Max marks |
|--|--|------------|
| Company Profile: | | |
| 1 | Avg. annual turnover last 5 years | 5 |
| 2 | Positive net worth last 3 years | 3 |
| 3 | Experience: | |
| a. | Past 10 years construction experience | 5 |
| b. | International experience | 2 |
| Contracts of Similar Size and Nature: | | |
| 4 | Design and execution/execution of urban road projects including: <ul style="list-style-type: none"> • Construction of urban roads/street • Street lighting especially at medians and kerbside • Construction for junction improvement | 20 |
| 5 | Design and execution/execution of urban road projects including: <ul style="list-style-type: none"> • Footpath construction (including overground utilities, street furniture, cycletracks, landscaping, and parking bays) | 20 |
| 6 | Laying of underground utilities | 15 |
| 7 | Approach and methodology | 10 |
| 8 | Resource deployment The CVs of the Following personnel shall be provided in the technical proposal: Project Manager, Site Engineer, Quality Assurance Engineer, MEP (mechanical-electrical-plumbing) Expert, Horticulture/Landscape expert, Architect | 20 |
| Total | | 100 |
| The minimum qualifying marks – Seventy (70) The financial bids of those bidders would be opened whosoever secure at least 70 points/marks in their technical Qualification Proposal as per the criteria specified above | | |

scope of work 03

pre-construction phase

- Prepare a detailed programme showing the stages, sequence, and timing of all parts of work. It should include the resources, men, material, and equipment required with clear critical path to execute the work as per agreed implementation schedules by the employer.

- Timelines should be clearly defined. They should include estimated completion date and number of working days.

- Method statement for all works, including transport and delivery of materials, site works including earth works, hard works installation, plant protection, temporary storage, etc. should be clearly defined.

- Procurement schedule for all materials (including utility services, landscape elements, site furnishings, lighting, bus stops, public toilets, etc.).

- Existing and future availability of materials.

- All samples for material, their types and numbers are to be submitted as required and approved by the employer prior to commencement of works on site.

- Product certificates for manufactured products should be submitted.

- Landscape indicating species, height, spread, and root ball size, for final approval by the client. Any agreed substitutions to plants species or specifications should be included.

- Site arrangement layout for temporary structures, storage, utilities, etc. to be planned.

- Phasing plan to be submitted for approval to the employer prior to commencement of site work. Contractor has to ensure that there is little or no disturbance to the traffic, while planning the implementation phasing.

- Consultation will be required with the relevant authorities for construction phasing.

- Method statements on how risks from hazards will be addressed and recorded.

- Procedures for carrying out risk assessments and risk mitigation.

- Emergency procedures including those for fire prevention and escape.

- Procedures for ensuring that all persons on site have received relevant health and safety information and training.

- Plan should include details on type and quantities of the waste generated including demolition waste, day to day generated waste, and safe disposal of the same, keeping in mind the environmental and social considerations, etc.

- Detail description of the waste management methods and actions.

- Record keeping procedures.

- Auditing protocols.

detailed programme of work

procurement plan

material/product samples

site management plan

health and safety plan

site waste management plan

traffic management

The traffic management plan shall include, but not be limited to, such items as pedestrian walkway, signages, application and/or removal of pavement markings, roadway lighting, methods and devices for delineation, channelisation, and placement with careful strategy drawn out against project plan for construction activities.

The traffic management plan should be in place during construction activities and trial run. During construction, traffic management plan should address:

- Road user safety
- Traffic flow
- Reduction in delay
- Access arrangement for adjoining properties
- Pedestrian and cyclist provisions
- Parking for construction vehicles
- Incident management & emergency response plan
- Notices and community participation
- Special event traffic management plan
- Impact on structures

construction phase

This phase starts from the date of approved Good for Construction drawings (GFC).

The following items are proposed to be undertaken in this project.

- Site clearance, demolition, earthwork, temporary work, traffic diversion, barricading the construction site, utility shifting, and all ancillary work as shown in the drawings.
- Footpath reconstruction/retrofitting, stamped concrete surfacing, and concrete paver block finish as per design, providing parking spaces as per design with concrete finishing, provision of separate RCC type utility ducts with opening after every 10 m interval to house current and future utilities.
- Excavation of the trenches, relocation of median, removal of existing poles/transformers, etc. and other road related facilities as per standards/drawings.
- Shifting and providing new utility lines like stormwater, water supply, and sewer along with access chambers and electrical cables with connectivity to individual properties, feeder pillars, removal of the existing street light HT/LT poles, and provision of new decorative street light poles, etc.
- Removal of the existing ramps, walls, compounds, fencing, encroachments on road/footpath, and complete retrofitting of the footpaths.
- Provision of new ramps to access property, reconstruction of compound walls (wherever required), and reconstruction of access locations to property.
- Provision of cobbled finish at intersections and other traffic calming elements like islands, raised pedestrian crossings, etc.
- Relocation/removal and reconstruction of existing small shops.
- Provision of street furniture - concrete bollards, bollard seatings, FRP dustbins, bus stops.
- Provision of street signages, informatory and cautionary signages, road markings, demarcating cycle track and other pedestrian facilities as per the design and drawings.
- Landscaping, plantation of various species of trees, shrubs, and bushes and PVC pipe line work.

intersection and street redesigning

- To conduct (one-way movement – map enclosed) trial run on the identified stretch

- The contractor is required to submit a structured approach for the development of a traffic management strategy which shall be considered, to minimise delay and inconvenience to road users during construction of road alignment.

- The contractor shall be responsible for the control, guidance, and protection of all road and pedestrian traffic along the entire road improvement stretch, and would manage traffic to minimise any delays and disruptions to vehicular and pedestrian access and movement.

The trial run to be carried out for at least two weeks time preferably on the normal days. Before implementing the trial run, the contractor should prepare a plan of action which needs to be approved by the client and traffic police.

- The traffic management scheme to be published in the newspapers and handouts to be distributed to inform the local public of the area, starting atleast two days prior to the first test run day.

- Traffic signages needs to be installed at strategic locations as discussed by the traffic police.

- Along with signages, contractor would also provide bollards/traffic cones/barricades to manage the traffic at critical locations.

- Contractor has to assist traffic police by deploying sufficiently trained traffic marshals to regulate the traffic.

post-construction phase

Post construction activities shall include defect liability and also maintenance of roads, landscape, and the utilities laid by the contractor on the smart roads. Any faults, repair and general maintenance, watering of landscape, etc. shall start from the date of practical completion for a period of 24 months and the contractor shall undertake all responsibility for defects of the equipment and landscape materials during this period.

special instructions for work execution 04

- The contractor should execute the work, causing minimum interference to the existing services in the road in co-ordination with the respective expert of the corporation.

- It is the responsibility of the contractor to execute the work, including excavation of earth and laying new elements or services as per the proposed design, in conjunction with the existing services over and below the ground level.

- Contractor has to inform the line (concerned) department immediately, if any underground services are found hindering the work, and further any re-alignment or damage of the services has to be repaired as per instruction from the line department.

- Any major deviation from the plan shall be reported immediately to the architect/engineer incharge of the project management team.

- It is integral for the contractor to consider the required quantity and the respective amount incurred related to the existing services interfered or essential services required (only related to existing scenario), so as to execute the project related work.

traffic diversion and disturbances

trail run

- The design drawings shall be supplemented by working drawings prepared by the contractor, which are required for the execution of the works. These working drawings shall include, electrical single line drawings, mechanical drawings, piping drawings setting out construction details, layouts, utility relocation and protection, and any other detail the engineer may ask during construction.

contractor's facilities

site offices of the contractor

- The site office with all those provisions mentioned above shall be provided and maintained by the contractor throughout the whole construction period until three months after the issuance of the preliminary Handing Over Certificate.
- The office and its facilities, will not however be removed from the site without prior written approval of the engineer.

surveying equipment

- The contractor shall provide one approved set of surveying and measuring equipment for the sole use of the engineer's representative.
- The contractor shall be solely responsible for the maintenance of all such instruments and equipments, and shall ensure that they are in good condition at all times.

laboratory and testing

- The contractor shall establish full-fledged field laboratory with all testing equipment for testing of the materials and finished products.
- All materials shall be tested as per Indian Standards. The rates quoted for concrete shall be inclusive of cost for establishing laboratory for testing.

progress photographs and reports

- Contractor shall submit monthly six progress photographs as part of his monthly progress report.
- Each photograph shall be mounted on A4 size chart paper on which the following information shall be written:

Name of the project
Location
Type of work
Serial number of the photographs
Date of photographs

safety on site

- The contractor shall appoint a Safety Officer who will be in charge of all safety measures. The workers should use safety equipments like helmets, gloves, shoes, etc. for their safety.

as-built drawings

- The contractor shall prepare as-built drawings and certify on these drawings that the drawings reflect the actual work executed/installed.



Fig. (facing page)
Harrington Road, Chennai

request for proposal

for procurement of implementing agency for operation and maintenance of complete streets

scope of work

The concessionaire shall undertake the following works during the contract period, except for the list of works covered by the contractor during his defect liability period.

The concessionaire shall submit the operation and maintenance manual for the fruitful operation of the works. The concessionaire will have the liberty to visit the operating works during the defect liability period and satisfy himself about the on-going operations. In case he does not visit and a defect is observed, then the engineer's opinion shall be final and binding.

During the operation and maintenance period, the concessionaire should prepare the details of work carried out on daily basis, the same should be submitted as a weekly and monthly report to the engineer-in-charge or his authorised representative.

O&M activities covered under the project include the following:

01 maintenance

a sidewalk/plaza maintenance

stone paving installation and replacement

- To replace an individual unit, or an area of paving, one unit needs to be completely removed from the paving. Other units can then easily be removed, if required.
- Brush off any jointing sand adhering to the edges of the blocks or chip off any mortar adhering to the edges of flags.
- The exposed bedding layer can be floated, troweled or screeded to prepare it for replacing the paving units. If correcting levels, add or remove bedding material as required.
- After breaking up old pavement, remove and recycle as much as possible.
- Regular visual inspection: It is necessary to observe for appearance of new damages in the repaired stone pieces, as well as healthy parts.
- Use same quality stone for paving replacement.

cleaning stone paving

Regular maintenance and good cleaning practices will enhance the overall appearance of the paving in the long term.

- The cleaning speed should be slow to control the effects that occur.
- The selected method should not produce products that alter the stone items.
- The method chosen should not damage the surface of the piece.
- If necessary, stone paving surfaces may be washed with brush and water or using high pressure hoses. If the latter, care should be taken not to blast away sand in joints. Do not use high pressure jets or suction cleaners for at least three months to allow normal build up of organic material.

landscape maintenance

- All dead trees shall be replaced by same tree species of same height.

- It is to be ensured that the trees and plants, after being planted do not get damaged due to the construction works carried out on the site.

- Prune trees and shrubs during the dormant season to facilitate proper growth and sight lines for vehicles and pedestrians.

- Keep basins and planting areas free of weeds. Remove weeds manually or by torch. Use broadcast herbicides only as a last resort and use approved natural herbicides. Avoid application of fertilizer if rain is expected.

- Leaves, twigs, chips, or other debris should be cleared from the gutter or paved shoulder.

street/road repair and maintenance b

- Schedule asphalt and concrete removal activities for dry weather.

- After breaking up old pavement, sweep up materials thoroughly to avoid contact with rainfall and storm water runoff. Recycle as much material as possible, and properly dispose of non-recyclable materials.

- Avoid mixing excess amounts of fresh concrete or cement mortar on-site.

- Store dry and wet materials under cover, protected from rainfall and runoff.

- Wash out concrete transit mixers only in designated wash-out areas where the water will flow into drums or settling ponds or onto dirt or stockpiles of aggregate base or sand.

- Whenever possible, return left-over materials in the mixer barrel to the yard for recycling. Dispose small amounts of excess concrete, grout, and mortar in the trash.

- Stockpile materials away from streets, gutter areas, storm drain inlets or watercourses. During wet weather, cover stockpiles with plastic tarps or berm around them if necessary to prevent transport of materials in runoff.

- Pre-heat, transfer or load hot bituminous material away from drainage systems or watercourses. Cover and seal nearby storm drain inlets and manholes before applying seal coat, slurry seal, etc. Leave covers in place until job is complete and until all water from emulsified oil sealants has drained or evaporated. Clean any collected materials from these covered manholes and drains for proper disposal.

- After the job is complete, remove stockpiles (asphalt materials, sand, etc.) as soon as possible.

- All signage should be checked regularly for any damage.

- The damaged sign boards should be immediately replaced to avoid inconvenience to the users.

- Road markings should be repainted if necessary.

asphalt/concrete removal

concrete installation and replacement

patching, resurfacing, and surface sealing

signing and striping

jersey barrier maintenance

- The areas around the median/barrier should be checked for litter, spattering, and stains.
- Wet or dry cleaning method must be adopted as required.
- In case of scrapped paint or discoloration due to weather or external factors, the units may be repainted.

c street/road/sidewalk sweeping and cleaning

sweeping timing and frequency

- Define the street sweeping programme, and set priorities for sweeping frequency based on factors such as traffic volume, land use and get it approved by the Corporation.
- Establish and maintain a consistent sweeping schedule.
- Establish and implement a record-keeping system to evaluate the effectiveness of the sweeping programme.

observations of material accumulation

- Sweeping equipment operation and selection.
- Ensure that equipment operators are operating equipment according to manufacturer's recommendations.
- Maintain equipment in good condition and purchase replacement equipment, if required.

d kerb maintenance

- Deteriorated kerbs should be removed and replaced with same quality kerbs.
- For installing the kerb stones, first it needs to be outlined where the stones are to be placed, and the height above the square where they are going to be placed.
- Water level and ropes should be used to maintain uniformity of the surface while installing the kerb stones.
- The stones must be secured from the front and behind in joints, which can be done with the help of concrete bedding.
- Preventive maintenance includes regular deck flushing and sealing the joints with waterproofing sealants.
- Painting of kerbs, if required, should be done as per traffic police norms during the maintenance period.

e maintenance of lay-byes

- The lay-bye markings should be visually inspected for any damage, and repainted if necessary.
- The changing points at the lay-byes should be inspected regularly and any damage should be quickly attended to.
- It should be ensured that the lay-byes do not get encroached by temporary shops, settlements or obstacles which shall defeat the purpose of the space, in co-ordination with

the local traffic police or concerned departments, keeping the supervising team of the Municipal authorities informed.

maintenance of street furniture f

• To maximize life expectancy the street furniture, they should be visually inspected on a regular basis for any signs of damage, vandalism, breakdown of surface finish, build-up of salt, dirt or atmospheric residue, and loose fixings.

• Damaged items shall be replaced, if they cannot be repaired.

• All cleaning and maintenance should be recorded, detailing the method of cleaning, what products have been used, and what repair work has been undertaken.

• During the establishment period all trees and shrubs shall be watered by thorough deep watering at regular intervals.

• Prune trees and shrubs during the dormant season to facilitate proper growth and sight lines for vehicles and pedestrians.

• Keep basins and planting areas free of weeds. Remove weeds manually or by torch. Use broadcast herbicides only as a last resort and use approved natural herbicides. Avoid application of fertilizer if rain is expected.

• Do not leave leaves, twigs, chips, or other debris in the gutter or paved shoulder.

• Post "No Littering" signs where needed and enforce anti-littering laws and encourage public education efforts to include anti-littering messages.

• Empty dustbins frequently to prevent spills.

• Wall paintings and installations should be consistently checked for damage and vandalism.

• Any damage must be repaired as early as possible.

• Illegal graffiti should be removed using mechanical or chemical removal.

• The surface maybe repainted with contextual designs approved by the authorities.

event organising and management 02

Create an annual plan of events including a basic plan for promotion, marketing, and funding. In addition, provide options of themes for these events.

• The events should be held at regular intervals – at least once a month on various themes, selected in accordance with the Corporation.

• Major events shall be organised on a bigger scale on special occasions and festivals like Pongal, Diwali, and as told by the Corporation. This will be a maximum of three events per year.

f benches and dustbins

vegetation

litter control

street art and graffiti

event plan

event organising

- Provide tactical support to the Corporation, in case of events, including development of the event and marketing material and outreach to participants and attendees.
- Provide technical support to record and archive the events.
- Promotions: The concessionaire shall be responsible for organising the whole event, right from selecting theme, preparing promotion material, promoting the event for public participation, organising public participation activities, setting up of audio and visual interaction mediums, using virtual reality as a medium of communication, all at discretion of the Corporation.
- The site shall be thoroughly cleaned and swept post event and should cause no hindrance to the regular public in any manner.

revenue and funding

- Identify potential sponsors and maintain a directory.
- Contact and confirm sponsors for each event.
- Communicate with sponsors on their requirements, deadlines, and deliverables.
- Manage budget during complete pre-event planning.

03 battery-operated cars

- Operate battery-operated cars and ensure their proper maintenance.
- Appointment of duly licensed drivers to ensure their continued and uninterrupted service.
- Coordinate with the Corporation and the electrical agencies for construction of Battery Charging stations at necessary locations.
- Parking bays must be provided for battery-operated cars with no hindrance to pedestrian movement.

04 monitoring

- Conduct biannual surveys to assess usage of plaza, for example, increase in footfall, improvement in air quality, increase in retail activity, etc.
- Conduct periodic surveys to check physical condition of the plaza, condition of seating, lights, etc.

quality and service failures

| No. | Performance indicator | Target | Failure point | Payment to be made |
|-----|---|--|---|---------------------------------|
| 1 | Availability of site engineer during the operation and maintenance period | Less than 3 incidents noticed during each payment period | Corporation observed 3 or more cases during their scheduled site visits/ meetings in a payment period | INR. 5,000 per additional case |
| 2 | Cleaning and maintenance of edge to edge right of way as per the directions of engineer in charge | Less than 3 incidents noticed during each payment period | Corporation observed 3 or more cases during their scheduled site visits in a payment period | INR. 10,000 per additional case |
| 3 | Proper maintenance of edge to edge as per the standards given in the tender document | Less than 3 incidents noticed during each payment period | Corporation observed 3 or more cases during their scheduled site visits in a payment period | INR. 10,000 per additional case |

key resource requirement

| No. | Resource role | Number of personnel | Requirement |
|-----|---|---------------------|-----------------------------------|
| 1 | Team Leader | 1 | BE Civil with 5 years experience |
| 2 | Site Engineer | 4 | DCE Civil with 2 years experience |
| 3 | Foreman/ Supervisor | 4 | 2 years experience |
| 4 | Event management agency - Creative designer, AV expert, material procurement expert are mandatory | 5 | As mentioned in the RfP |

list of references

Following are some of the acts, laws, and initiatives undertaken until now by the Central and the State Governments, and other organisations in the road and transportation sector prominently related to vehicles, road construction, and road users. The Complete Streets framework toolkit has taken into consideration the information and suggestions as mentioned in these studies.

Indian Road Congress Guidelines

The Indian Roads Congress (IRC) was set up by the Government of India in consultation with the State Governments in December, 1934 and is a registered society under the Registration of Society Act. It is the premier body of Highways Engineers in India. The principal objectives of the India Roads Congress are to provide a national forum for regular pooling of experience and ideas on all matters concerned with the construction and maintenance of highways, to recommend standard specifications, and to provide a platform for the expression of professional opinion on matters relating to roads and road transport, including those of organisations and administration. It also publishes journals, monthly magazines, and research bulletins.

Few of such journals regarding design of urban roads have been considered in the study for the framework documents. The documents recommend to follow the given IRC for the technical specifications and details for construction of street elements:

1. IRC:35-2015 Code of Practice for Road Markings
2. IRC:36-2010 Recommended Practice for Construction of Earth Embankments and Subgrade for Road Works
3. IRC:37-2012 Guidelines for the Design of Flexible pavements
4. IRC:67-2012 Code of practice for Road Signs
5. IRC:70-2017 Guidelines on Regulation and Control of Mixed Traffic in Urban Areas
6. IRC:98-2011 Guidelines on Accommodation of Utility Services on Roads in Urban Areas
7. IRC:99-2018 Guidelines for Traffic Calming Measures in Urban and Rural Areas
8. IRC:103-2012 Guidelines for Pedestrian Facilities
9. IRC:SP:50-2013 Guidelines on Urban Drainage
10. IRC:SP:055 Guidelines on Traffic Management in Work Zones
11. IRC:SP:057 Guidelines for Quality Systems for Road Construction
12. IRC:SP:112-2017 Manual for Quality Control in Road and Bridge Works
13. IRC:SP:117-2018 Manual on Universal Accessibility for Urban Roads and Streets
14. IRC:SP:119-2018 Manual of Planting and Landscaping of Urban Roads

MoRTH Specifications

The Ministry of Road Transport and Highways, is a ministry of the Government of India. It is the apex body for formulation and administration of the rules, regulations, and laws relating to road transport and transport research in India. Some of the MoRTH regulations and specifications referred in the Complete Streets framework documents have been listed below:

1. MoRTH Section 300: Earthwork, Erosion Control and Drainage
2. MoRTH Section 400: Sub-Base, Bases Not-Bituminous and Shoulders
3. MoRTH Section 500: Base and Surface Courses (Bituminous)
4. MoRTH Section 800: Traffic Signs, Markings and Other Road Appurtenances

Design of Urban Roads-Code of Practice, 2012¹

The code of practice for designing of urban roads has been prepared by the Transportation Research and Injury Prevention Programme (TRIPP) for the Institute of Urban Transport (IUT), Ministry of Urban Development. The primary purpose of this document is to provide a code of practice for various urban road components. It has been developed in five parts:

- Part I : Urban road cross section design
- Part II : Intersection design
- Part III: Road markings
- Part IV : Signages
- Part V : Traffic Calming methods

Among other recommended codes, the document has two major variations from IRC codes in terms of road design for intended speed limit and linking of lane width with speed limit.

Motor Vehicles Act²

The Motor Vehicles Act, 1988 is an Act of the Parliament of India, which regulates all aspects of road transport vehicles. The Act came into force from 1 July 1989. It replaced Motor Vehicles Act, 1939 which earlier replaced the first such enactment Motor Vehicles Act, 1914. The Act provides in detail, the legislative provisions regarding licensing of drivers/ conductors, registration of motor vehicles, control of motor vehicles through permits, special provisions relating to State Transport Undertakings, traffic regulation, insurance, liability, offences, and penalties, etc.

Disabilities Act³

The Rights of Persons with Disabilities Act replaces the Persons with Disabilities (Equal Opportunities, Protection of Rights and Full Participation) Act, 1995. It fulfills the obligations to the United National Convention on the Rights of Persons with Disabilities (UNCRPD), to which India is a signatory. The Act came into force during December 2016.

Accessibility is one of the rights that is given importance under this Act, which makes it mandatory to provide for disabled friendly design of public places, including roads and streets. The rules under this Act, have specified the standards for accessibility through Harmonised Guidelines and Space Standards for Barrier Free Built Environment for Persons With Disabilities and Elderly Persons⁴. The guidelines, prepared by the Ministry of Urban Development are comprehensive guidelines, inclusive of all provisions updated and harmonised to act as an easy reference to Practitioner's Guide for Barrier Free Designs with universal access, responding to the varying needs of the persons with disabilities.

¹ <http://mohua.gov.in/cms/Design-of-Urban.php>

² <http://www.tn.gov.in/sta/Mvact1988.pdf>

http://164.100.47.4/BillsTexts/LSBillTexts/PassedLoksabha/214C_2016_LS_Eng.pdf

³ <http://disabilityaffairs.gov.in/upload/uploadfiles/files/RPWD%20ACT%202016.pdf>

⁴ <https://cpwd.gov.in/Publication/Harmonisedguidelinesreleasedon23rdMarch2016.pdf>

The Guidelines and Toolkits for Urban Transport Development

The Guidelines and Toolkits for Urban Transport Development were prepared by a Technical Assistance on Urban Transport Strategy (TA 4836-IND) funded by the Asian Development Bank for the Ministry of Urban Development (MoUD), Government of India. These documents are designed to help decision makers and practitioners in States and Municipal Governments, who are concerned with urban transport development in medium-sized cities in India.

It consists of 5 modules addressing topics like -

- Comprehensive mobility plans⁵
- Bus Rapid Transit Systems (BRTS)
- Guidelines for Bus service improvement
- Guidelines for parking measure
- Guidelines for NMT measures

The National Urban Transport Policy (April 2006)⁶

It was approved by the Government of India to tackle urban mobility issues to ensure a safe and sustainable urban mobility in the coming decades. It provides for integrated land use and transport plans in cities, coordinated planning for urban transport, people oriented equitable allocation of road space, capital support in the form of equity participation and/or viability gap funding, innovative financing, dedicated urban transport funds, non-motorised transport, car restraint measures, clean fuel and vehicle technology, private sector participation, and pilot projects in cities to establish models of best practices.

Recommendations of Working Group on 12th FYP⁷

The Working Group on Urban Transport for the 12th Five Year Plan has made recommendations on investments and plans on nine broad themes in urban transport which were identified in line with the National Urban Transport Policy (NUTP) developed by the Government of India.

Study on Traffic and Transportation Policies and Strategies in Urban Areas in India, MOUD, 2008⁸

The study aimed at updating the transportation information and projections made from the previous study 'Traffic and Transportation Policies and Strategies in Urban Areas in India 1994', in order to review the National Urban Transport Policy in light of the new and comprehensive data provided within this report.

Service Level Benchmarking, 2009⁹

Since 2009, the Ministry of Housing and Urban Affairs (then titled Ministry of Urban Development) has adopted the practice of service level benchmarking. Through the Service Level Benchmarking (SLB) initiative, the Ministry hopes to create a robust set of indicators across sectors for which data would be collected at the city levels and collated and published at the National level. This would then help create a ranking for cities, aided by a positive competitive spirit. At the same time, cities were also expected to set targets for themselves and better their performances over time.

Within urban transport, pedestrian and non-motorised transport facilities were assigned indicators - such as the share of city roads with footpaths and the coverage and efficiency of street lighting, etc.

National Mission on Sustainable Habitat: Report of the Sub-Committee on Urban Transport

Under the National Action Plan for Climate Change, the National Mission on Sustainable Habitat has been launched to cover various aspects, which include better urban planning and modal shift to public transport. Regarding urban transport, the objectives of the National Mission on Sustainable Habitat (NMSH) are "To address the issue of mitigating climate change by taking appropriate action with respect to the transport sector such as evolving integrated land use and transportation plans, achieving a modal shift from private to public mode of transportation, encouraging the use of non-motorised transport, improving fuel efficiency, and encouraging use of alternative fuels, etc.

UTTIPEC Guidelines for Street Design¹⁰

As per the recommendations of National Urban Transport Policy, DDA, Delhi has notified Unified Traffic and Transportation Infrastructure (Plg. & Engg.) Centre (UTTIPEC) to enhance mobility, reduce congestion, and to promote traffic safety by adopting standard transport planning practices.

Recently UTTIPEC has published street design guidelines to promote sustainable transportation system in the city of Delhi.

The Street Vendors (Protection of Livelihood and Regulation of Street Vending) Act, 2014¹¹

Street Vendors (Protection of Livelihood and Regulation of Street Vending) Act, 2014 is an Act of the Parliament of India. This Act was drafted with the legislative intent of protecting the livelihood rights of street vendors as well as regulating street vending through demarcation of vending zones and laying out conditions/restrictions for street vending. The Act now governs over all matters in regards to the rights and duties of the street vendors in India.

⁵ https://smarnet.niua.org/sites/default/files/resources/file_1016201405372097.pdf

⁶ <http://www.iutindia.org/downloads/Documents.aspx>

⁷ http://planningcommission.gov.in/aboutus/committee/wrkgrp12/hud/wg_%20urban%20Transport.pdf

⁸ http://mohua.gov.in/upload/uploadfiles/files/final_Report.pdf

⁹ http://mohua.gov.in/upload/uploadfiles/files/Service_level.pdf

¹⁰ http://smartcities.gov.in/upload/uploadfiles/files/StreetGuidelines_DDA.pdf

¹¹ <http://legislative.gov.in/sites/default/files/A2014-7.pdf>

Chennai Non-Motorised Transport Policy, 2014¹²

The Chennai Municipal Corporation adopted a progressive non-motorised policy in October, 2014, to make walking and cycling its priority. The policy aims to arrest the current decline in walking and cycling in the city, by creating safe and pleasant network of footpaths, cycle tracks, greenways, and other NMT facilities.

Urban Street Design Guidelines, Pune 2016¹³

In accordance with the key principles of moving people before vehicles in National Urban Transport Policy, the Municipal Corporation of Pune adopted the 'Urban Street Design Guidelines' as a new policy document aimed at 'equitable allocation of street space'. The guidelines give an overview of the various elements that go into designing streets, making them universally accessible and also provide standard templates for different sizes and uses of streets.

Policy for Pedestrian Facilities and Safety, Pune 2016¹⁴

The Municipal Corporation of Pune, in 2016 adopted a Pedestrian Facilities and Safety Policy, keeping in view the focus set in NUTP and CMP for Pune. The policy establishes good quality public transport system as well as safe, adequate, and usable facilities for pedestrians and cyclists as the solutions to city's traffic problems and aims at providing consistent, high quality pedestrian infrastructure with equitable allocation of road space.

Public Parking Policy, Pune 2016¹⁵

The policy on Public Parking adopted by Pune Municipal Corporation in 2016, is expected to help the city in becoming more 'people friendly' than 'vehicle friendly'. The policy aspires to discourage usage of private modes, encourages efficient use of available parking spaces, aids in evolving a better transportation system, builds a strategy to reduce congestion, pollution, and also helps the public transport system to grow.

NMT Guidance Document, 2016¹⁶

The guidance document for preparing Non-Motorised Transport (NMT) plans has been undertaken by the Sustainable Urban Transport Project, Ministry of Urban Development (MoUD), Government of India (GOI) with support from Global Environment Facility (GEF), UNDP, and World Bank. The focus of the Guidance Document is to establish a systematic process for plan preparation, serving more as an implementation manual with checklists of potential alternatives, rather than providing technical standards for development of detailed specifications.

¹² <https://www.itdp.in/wp-content/uploads/2014/10/NMT-Policy.pdf>

¹³ https://pmc.gov.in/sites/default/files/road_img/USDG_Final_July2016.pdf

¹⁴ <http://smartcities.gov.in/upload/development/5a9009c9843cdPolicy%20for%20Pedestrian%20Facilities%20and%20Safety%20in%20Pune%20City.pdf>

¹⁵ <https://pmc.gov.in/sites/default/files/project-glimpses/PMC-public-parking-policy-English-revised-March2016-Final.pdf>

¹⁶ <https://smarnet.niua.org/sites/default/files/resources/nmtguidancefinal.pdf>

Coimbatore Street Design & Management Policy, 2017¹⁷

Keeping with the approach set-out in NUTP-2006, the Coimbatore City Municipal Corporation (CCMC) adopted a Street Design & Management Policy to ensure the implementation of high-quality transport systems. The policy seeks to achieve an environment that supports more equitable allocation of road space by incorporating a focus on non-motorised transport (NMT) and public transport (PT) in the planning, design, managing, and budgeting stages.

Ease of Living Index, 2018¹⁸

The SLB initiative has been reimagined and expanded into the Ease of Living Index, covering more sectors and aspects of citizen lives. Within transport however, the larger set of indicators remain largely similar to the earlier SLBs.

Specifications for Urban Road Execution, Tender SURE

Bangalore City Connect Foundation (BCCF) in conjunction with Indian Urban Space Foundation (IUSF) approached the State Government of Karnataka to build an Urban Road and Tender Manual in 2010. The publication contains guidelines on designs, specification, and procurement of contract for urban roads execution, with the priority on the comfort and safety of pedestrians and cyclists, as well as recognising the needs of street vendors and hawkers.

Urban Street Design Guide, NACTO

NACTO's (a non-profit organisation) 'Urban Street Design Guide' gives guidance through toolbox and tactics that cities can use to make streets safer, more livable, and more economically vibrant. The guide outlines both a clear vision for complete streets and a basic road map for how to bring them to fruition.

Better Streets, Better Cities, ITDP¹⁹

A street design manual for Indian cities prepared by ITDP, (a not for profit organisation) that discusses design details of various street elements and street sections on 'complete streets' principle.

Parking Basics, ITDP²⁰

Parking Basics, a guiding document by ITDP, outlines the key principles and steps involved in managing on-street parking and regulating off-street parking.

¹⁷ https://www.itdp.in/wp-content/uploads/2018/01/CoimbatoreStreetDesignandManagementPolicy_ITDP_170218.pdf

¹⁸ <https://easeofliving.niua.org/assets/upload/pdfs/ease-of-living-national-report.pdf>

¹⁹ <https://www.itdp.org/wp-content/uploads/2011/12/Better-Streets-Better-Cities-ITDP-2011.pdf>

²⁰ <https://www.itdp.org/wp-content/uploads/2015/10/Parking-Basics.pdf>

Footpath Design: A guide to creating footpaths, ITDP²¹

This design guide prepared by ITDP is a quick reference document, which highlights key concepts from the IRC Guidelines, including footpath design standards. The guide also draws from local and international best practices for some themes not covered in the IRC publication.

Footpath Fix, ITDP²²

Footpath Fix, the second volume after Footpath Design, is a step-by-step guide on footpath construction detailing for urban designers, municipal engineers, and contractors. The guide aims to highlight the steps of footpath construction in chronological order, from pre-excavation to above-ground construction. It also features necessary precautions, drawn from experience on-ground, that must be taken into consideration at each stage of the construction.

The work is licensed under a Creative Commons Attribution BY 4.0 License. Feel free to copy, distribute and transmit, as long as you attribute the work.



Prepared by



team
 Achuthan T D
 Ganesh Babu R P
 Nashwa Naushad
 Naveena Munuswamy
 Parin Visariya
 Pranjal Kulkarni
 Sruti Venkatakrisnan
 Vaishali Singh
 Venugopal A V
 Vishnu M J

editors
 Kashmira Dubash
 Pranjali Deshpande
 Sujata Saksena
 Vikas Thakar

manager
 Aswathy Dilip

All photographs and graphics by ITDP, unless otherwise mentioned.

²¹ https://www.itdp.in/wp-content/uploads/2014/04/05-Footpath-Design_Handout.pdf

²² <https://www.itdp.in/wp-content/uploads/2018/07/Footpath-Fix.pdf>

